

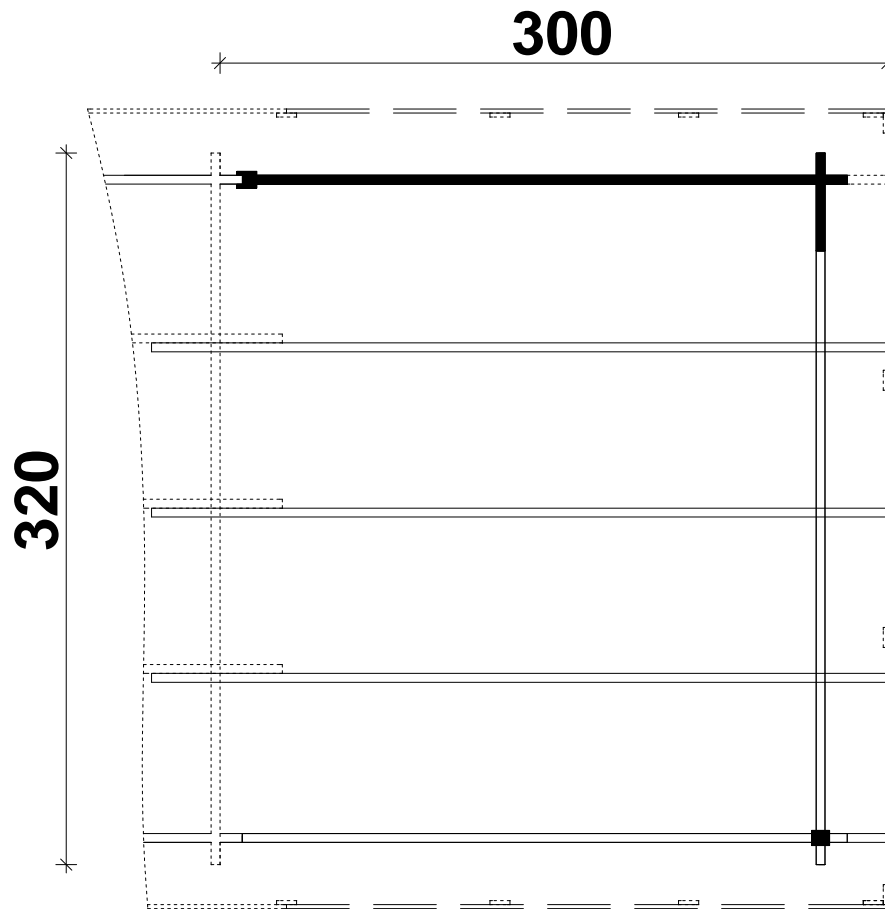









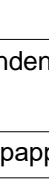
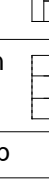
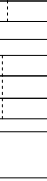
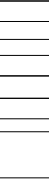
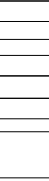

Viskan 4 B

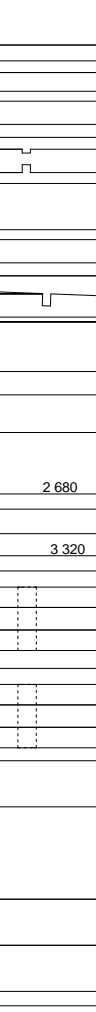
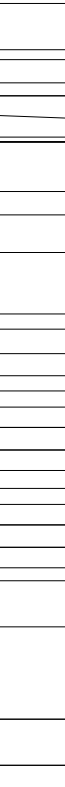
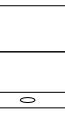
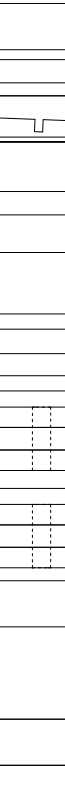
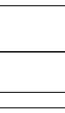
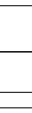
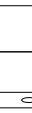
Byggyta: 300 x 320 cm Väggtjocklek: 40 mm

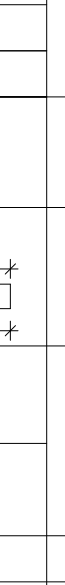

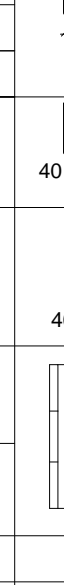
OBS! Alla mått är ungefärliga.

Viskan 4B

Nr	Beskrivning	Profil mm	Längd mm	Antal	
1	Grundreglar	45x70	2720	1	
2			290	1	
3			2678	1	
4			2678	16	
5			4340	2	
6			440	17	
7			3200	1	
8			3200	1	
9		40 x 114	3020	2	
10	Takreglar 	40x120	3320	3	
11	Blenden 		2720	2(1+1)	
12	Blenden 		--	--	
13	Takpapp		--	--	
14	Takbrädor	 18x88	--	--	
		 18x110	3510	28	
15		45x70	280	4	
16	Takpappsplåt	28x55	3000	1	
17	Stolpe 		70x90	1990	1
18	Stolpe 		76x90	1910	1
19	Reglerbart stolpstöd 			1	
20	Stormlist 	20x40	2010	2	
21	Skruv 4,0 x 40			1 Beutel	
22	Spik 2,5 x 50			1 Beutel	
23	Takpappsspik 3,0 x 15			--	
24	Skruv 4,5 x 70			1 Beutel	
25	Bult M 8 x 70, Mutter, Brickor			6	
26		40x143	280	3	
27	Bräda	18x90	210	1	
28			2365	1	
29	Slagbitar		300-400		

Viskan 4B

Vägg A

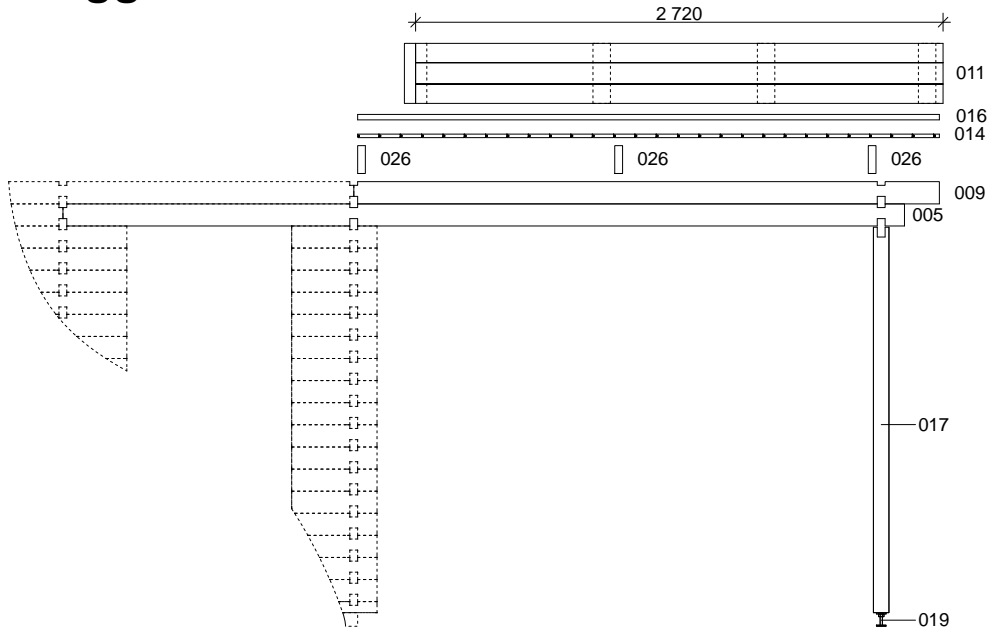

Vägg B

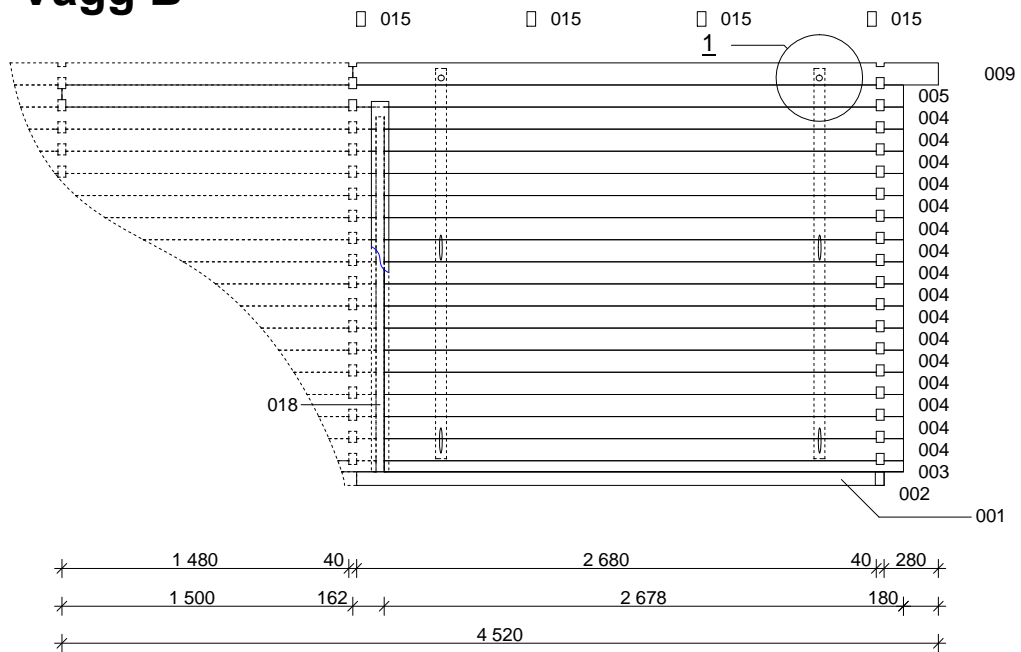

Viskan 4B

Vägg C

