

*Adam D*

1/8

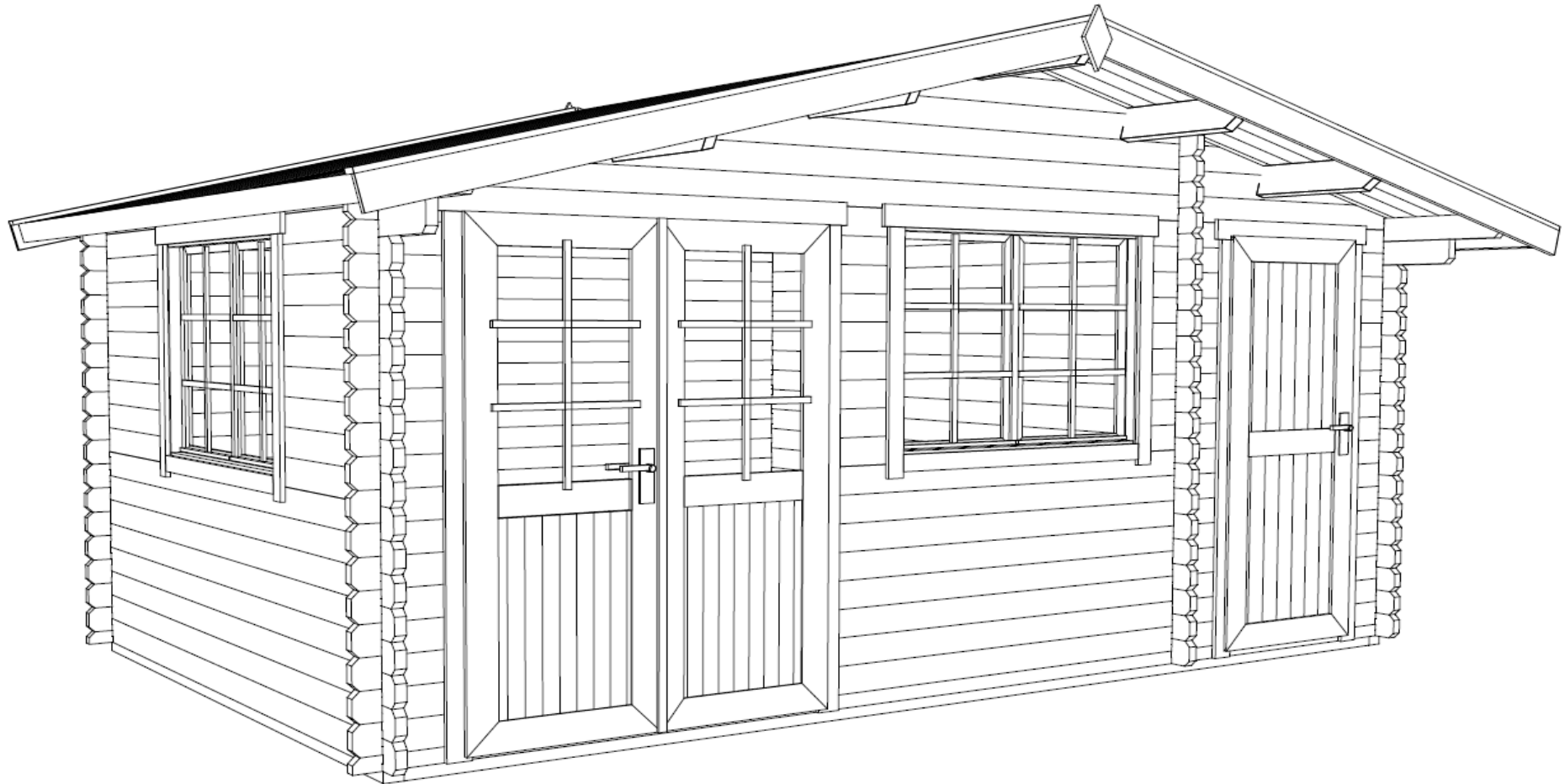

# GROUNDPLAN - GRUNDPLAN - PLAN DE MASSE

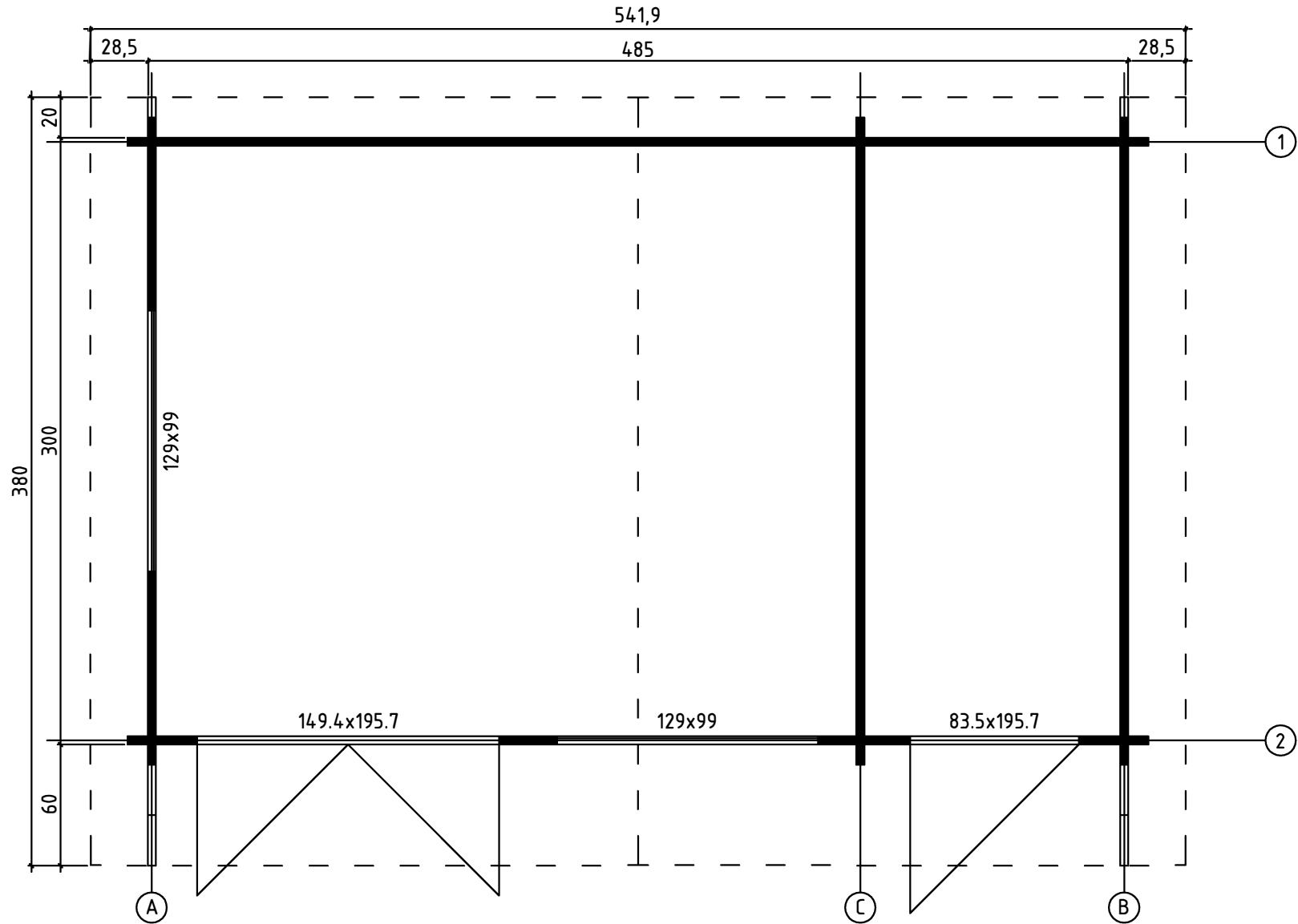

FOUNDATION - FUNDAMENT - FONDATION

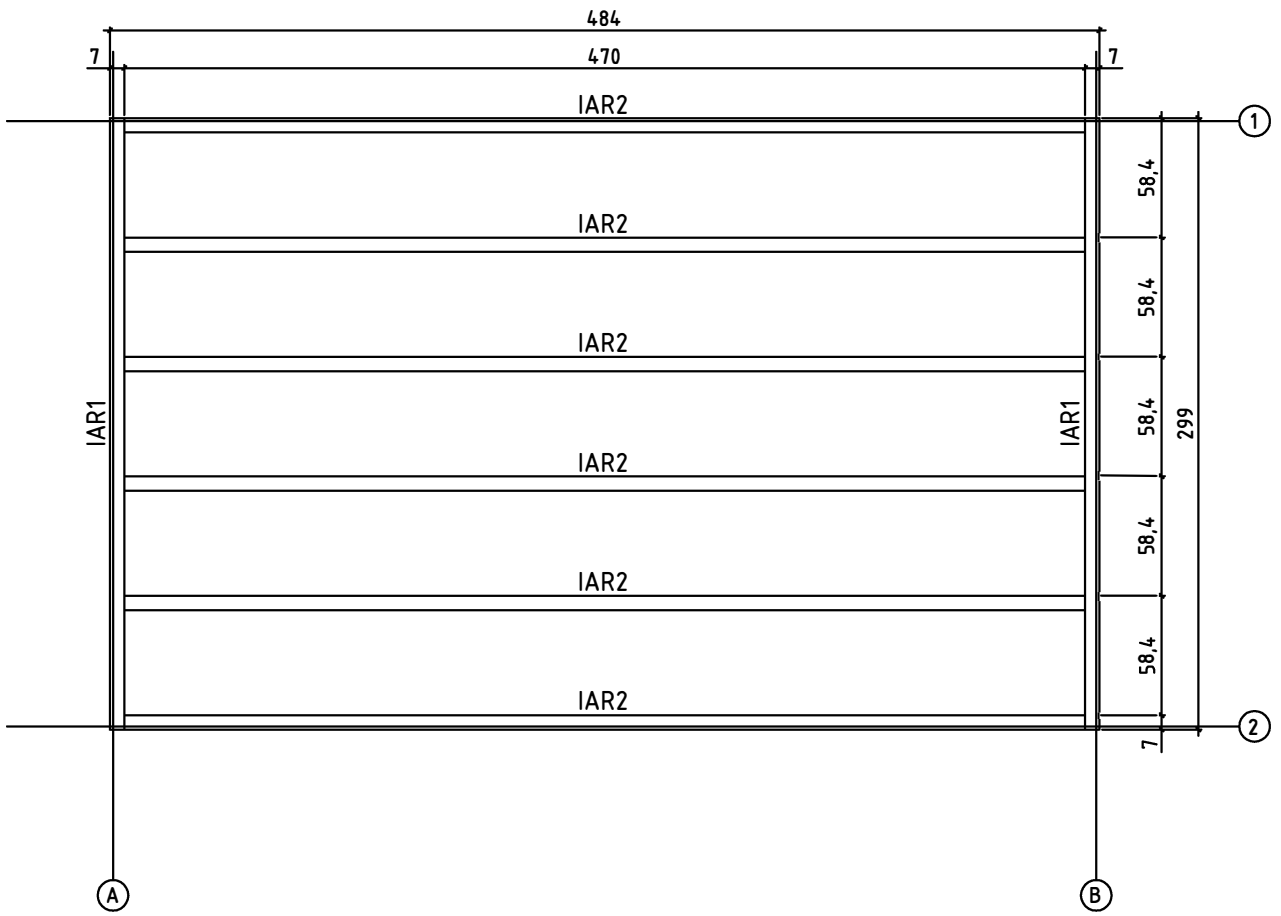



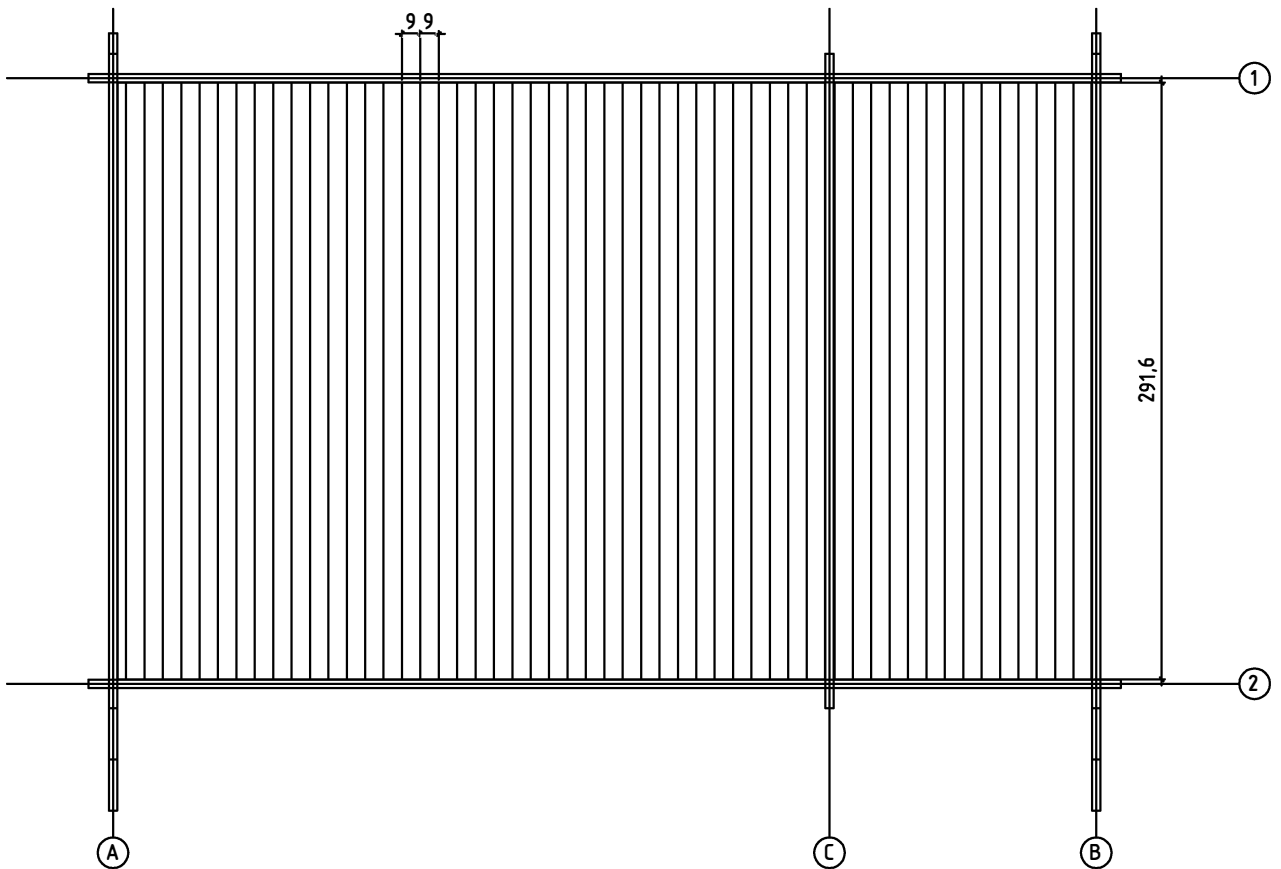



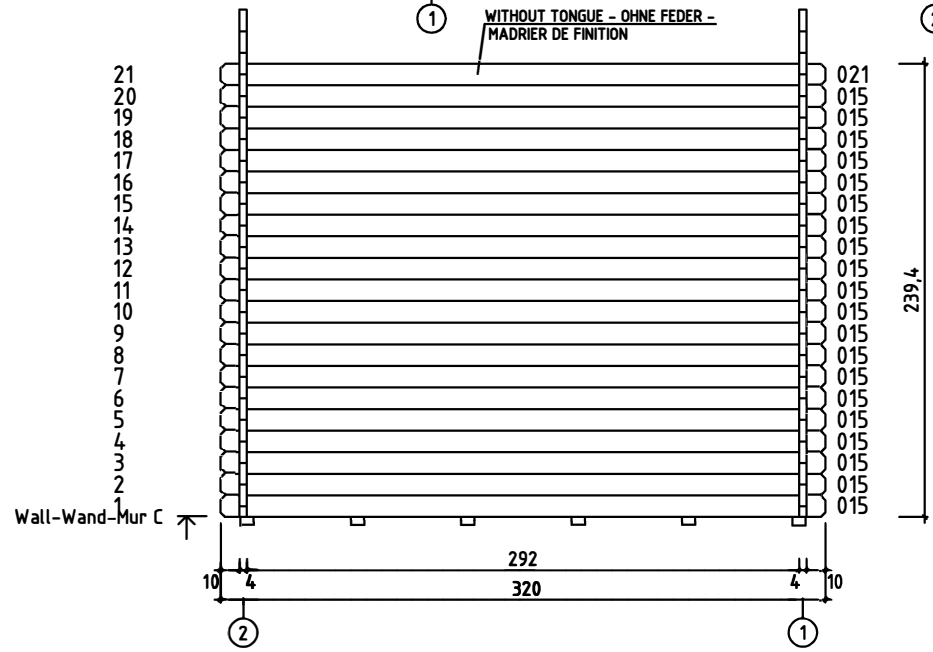
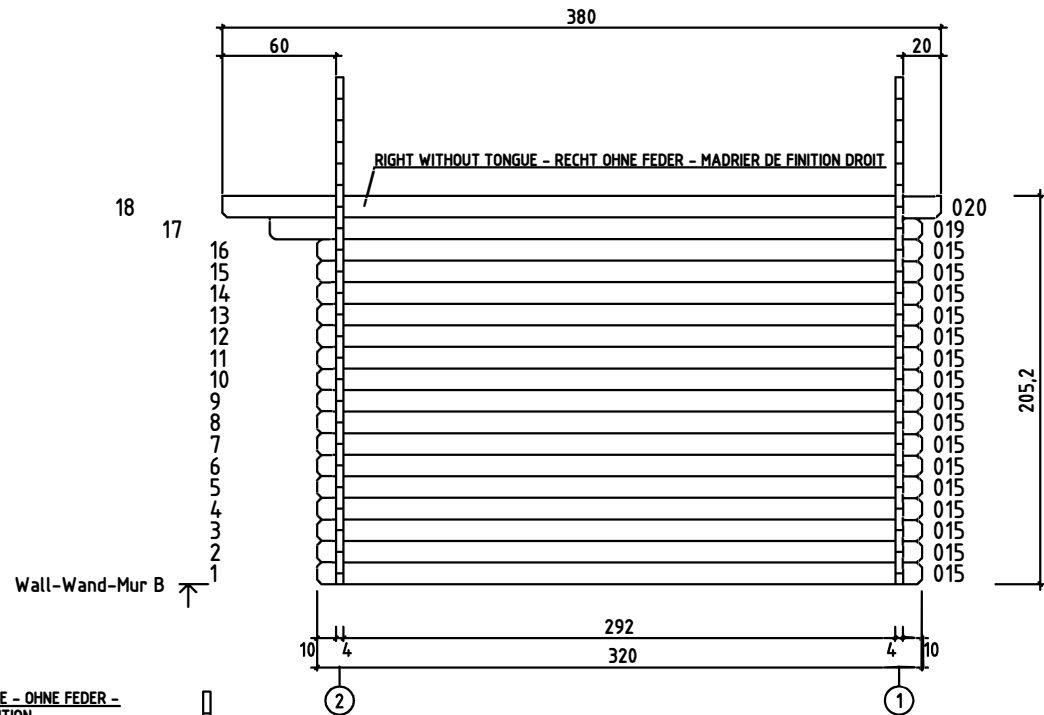
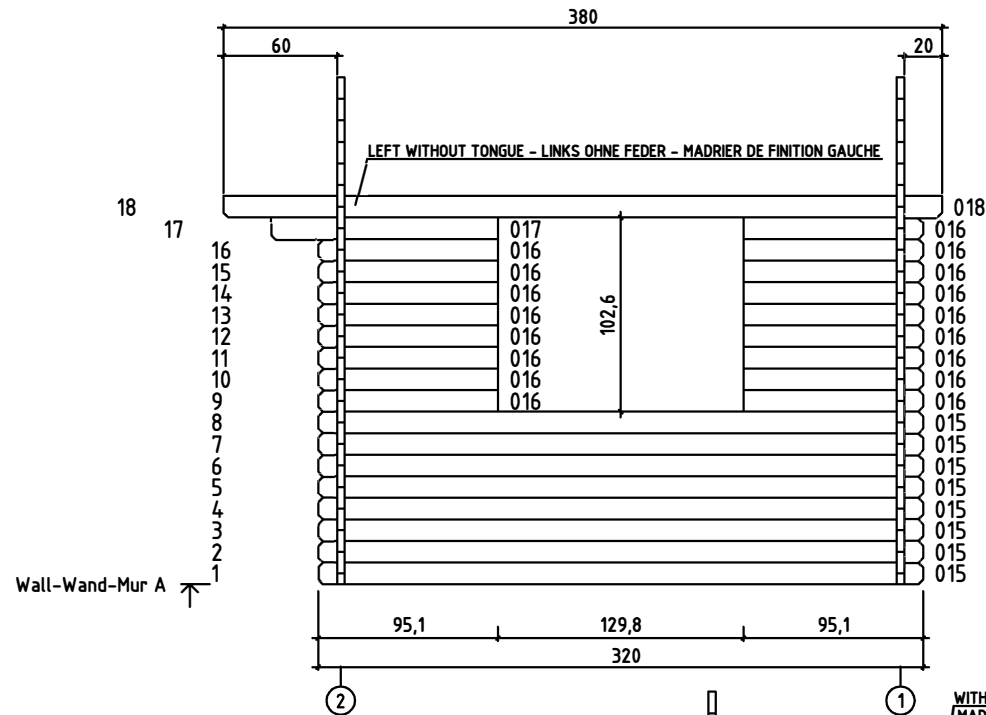





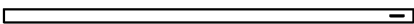

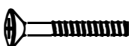

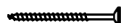

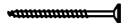
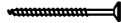

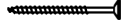
FLOOR BOARDS - FUSSBODENBRETTER - PLAN POSE PLANCHER

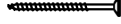
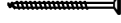
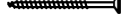













Pos	02.08.2016	Piece list - Stückliste - Liste des pièces	6/8	Q	P (mm)	L (mm)
001				1	40x57	5050
002				17	40x114	5050
009				2	40x57	340
010				1	40x57	2025
011				34	40x114	340
012				8	40x114	2025
013				9	40x114	279
014				9	40x114	448
015				44	40x114	3200
016				17	40x114	951
017				1	40x114	1201
018				1	40x120	3800
019				1	40x114	3450
020				1	40x120	3800
021				1	40x107	3200
W1-1 W2-1				1 1		
IAR2	FOUNDATION - FUNDAMENT - FONDATION 			6	70x45	4700
IAR1	FOUNDATION - FUNDAMENT - FONDATION 			2	70x45	2990
PPR1	ROOF BEAM - DACHBALKEN - PANNE DE TOIT 			1	44x140	3800
PR21	ROOF BEAM - DACHBALKEN - PANNE DE TOIT 			4	44x140	3800
	FLOOR BOARDS - FUSSBODENBRETTER - LAME DE PLANCHER 			53	90x18	2916
	ROOF BOARDS - DACHBRETTER - VOLIGES 			86	90x18	2800
	FLOOR FILLET - FUSSBODENLEISTE - CORNIERE DE FINITION DU PLANCHER 				18x18	21.1
	ROOFING FELT FILLET - DACHPAPPENLEISTE - BAGUETTE DE FIXATION DU FEUTRE BITUMEUX 			4	18x58	2850

Pos	02.08.2016	Piece list - Stückliste - Liste des pièces	7/8	Q	P (mm)	L (mm)
TB-1	FASCIA BOARD - TRAUFBRETT - BANDEAU DE TOIT			2	18x90	3800
DRV-1	ROOF EDGE REINFORCEMENT - DACHRANDVERSTÄRKUNG - CORNIERE DE RENFORT DE BORD DE TOIT			2	28x34	3800
KFS-1	STORM PROTECTION - STURMLEISTE - LATTE ANTI-TEMPETE			4	22x45	2050
	GABLE MOULDING - GIBELLEISTE - PLANCHE DE RIVE			4	18x120	2850
FS1	WINDOW HANDLE FITTINGS - FENSTERGRIFF - POIGNEE DE FENETRE			2		
FSP	BOLT FOR WINDOW HANDLE FITTINGS - BOLZEN FÜR FENSTERGRIFF BESCHLAG - VIS POUR FIXATION POIGNEE DE FENETRE			4		
HS1	SCREW FOR GEORGIAN BARS - SCHRAUBE FÜR SPROSSEN - VIS DE BARRES GEORGIENNE			24	2.5x20	
HS1	SCREW FOR GEORGIAN BARS - SCHRAUBE FÜR SPROSSEN - VIS DE BARRES GEORGIENNE			12	2.5x20	
HS8	SCREW FOR GABLE SEGMENT - SCHRAUBEN FÜR DECKBLATT - VIS POUR FIXATION LOSANGE DE FINITION			4	3.5x35	
HS9	SCREW FOR GABLE MOULDING - SCHRAUBEN FÜR GIBELLEISTE - VIS POUR FIXATION PLANCHE DE RIVE			32	3.5x50	
HS4	SCREW FOR WINDOW FILLET - SCHRAUBE FÜR GLASLEISTE - VIS DE FILET DE FENETRE			6	3x30	
HS4	SCREW FOR DOOR FILLET - SCHRAUBE ZUR BEFESTIGUNG TÜRLEISTE - VIS POUR FIXATION BAGUETTE D'ARRET DE PORTE			5	3x30	
HS12	SCREW FOR FASCIA BOARDS - SCHRAUBEN FÜR TRAUFBRETT - VIS POUR FIXATION BANDEAU DE TOIT			18	4x40	
HS12	SCREW FOR ROOF EDGE REINFORCEMENT - SCHRAUBEN FÜR DACHRANDVERSTÄRKUNG - VIS POUR FIXATION CORNIERE RENFORT DE BORD DE TOIT			18	4x40	
HS18	SCREW FOR FOUNDATION - SCHRAUBEN ZUR BEFESTIGUNG FUNDAMENT - VIS DE FIXATIONS DES POUTRELLES DE FONDATIONS			12	5x120	
HS18	SCREW FOR ROOF BEAMS - SCHRAUBEN FÜR DACHBALKEN - VIS POUR FIXATION PANNES DE TOIT			16	5x120	
HS18	SCREW FOR GABLE - SCHRAUBEN FÜR GIEBEL - VIS POUR FIXATION DES PIGNONS			26	5x120	
HS16	SCREW FOR 1. WALL BEAM - SCHRAUBE FÜR 1. BOHLENREIHE - VIS DE FIXATIONS 1ere RANGÉE DE MADRIERS AVEC POUTRELLES DE FONDATIONS			10	5x90	
HS16	SCREW FOR DOOR JAMB - SCHRAUBE FÜR TÜRRAHMEN - VIS DE FIXATION PARTIE HAUTE AVEC MONTANTS DU CADRE DE PORTE			4	5x90	
HS25	SCREW FOR DOORSTEP - SCHRAUBEN FÜR SWELLE - VIS POUR FIXATION BARRE DE SEUIL			5	4.5x65	
NF2	ZN NAIL FOR FLOOR FILLET - ZN NÄGEL FÜR FUSSBODENLEISTE - POINTE POUR CORNIERE DE FINITION DU PLANCHER			44	1.4x40	
SH40	HAMMER BLOCK - SCHLAGHOLZ - CALLE DE FRAPPE			1		
SFS	NUT FOR STORM PROTECTION - SCHRAUBENMUTTER FÜR STURMLEISTE - ECROU POUR LATTE ANTI-TEMPETE			8	D6	
NF4	ZN NAIL FOR ROOF - ZN NÄGEL FÜR DACHBRETTER - POINTE POUR FIXATION VOLIGES DE TOIT			364	2x50	
NF4	ZN NAIL FOR FLOOR - ZN NÄGEL FÜR FUSSBODENBRETTER - CLOUS POUR PLANCHER			330	2x50	

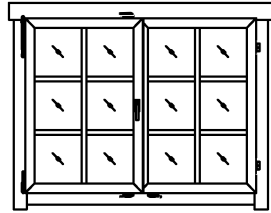
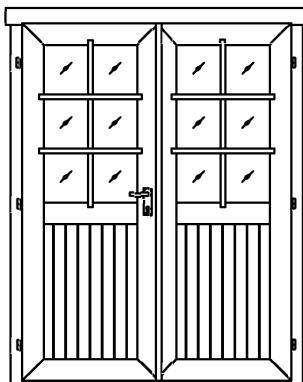
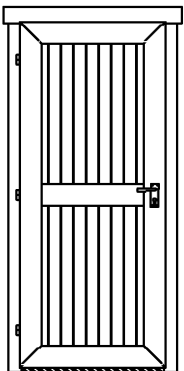
Pos	02.08.2016	Piece list - Stückliste - Liste des pièces	8/8	Q	P (mm)	L (mm)
NF5	ZN NAIL FOR ROOFING FELT FILLET - ZN NÄGEL FÜR DACHPAPPENLEISTE - POINTE POUR BAGUETTE DE FIXATION FEUTRE BITUMEUX			28	2x40	
BFS	BOLT FOR STORM PROTECTION - BOLZEN FÜR STURMLEISTE - BOULON POUR LATTE ANTI-TEMPETE			8	6x70	
GS	GABLE SEGMENT - DECKBLATT - LOSANGE DE FINITION			2		
DFS	WASHER FOR STORM PROTECTION - DICHTSCHEIBE FÜR STURMLEISTE - RONDELLE POUR LATTE ANTI-TEMPETE			8	D6	
TL4	DOOR HANDLE FITTINGS - TÜRGRIF - POIGNEE DE PORTE			2		
TL5	SET OF DOOR LOCK COVERS - SCHLOSSBLENDEN - SET DE GARNITURES DE PORTE			2		
	CYLINDER LOCK - ZYLINDERSCHLOSS - BARILLET DE PORTE			2	30/35	
	MALE BOLT HINGE FOR DOOR - TÜRRIEGEL - PARTIE MALE DE PAUMELLE DE PORTE			6	16/52	
	WINDOW - FENSTER - FENETRE 1290x990 SGC	TAK.1.106.SSV.b		2		
	DOOR - TÜR - PORTE 1494x1957 SGC	TUK.2.056.SVV.MMb		1		
	DOOR - TÜR - PORTE 835x1957 TC	UL.2.100.IVV.MM		1		