

Christer

1/8



13.10.2016

GROUNDPLAN - GRUNDPLAN - PLAN DE MASSE

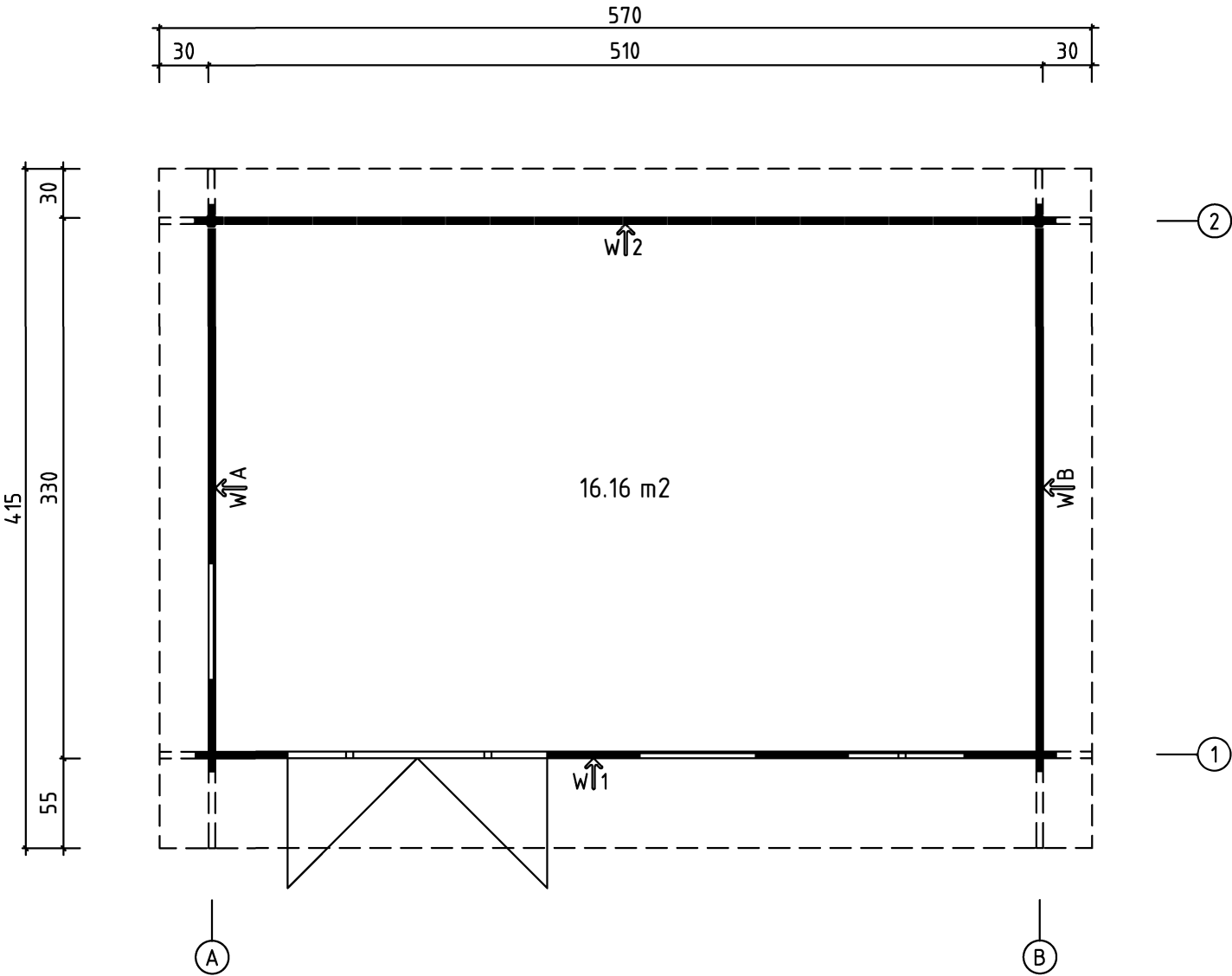

FOUNDATION - FUNDAMENT - FONDATION

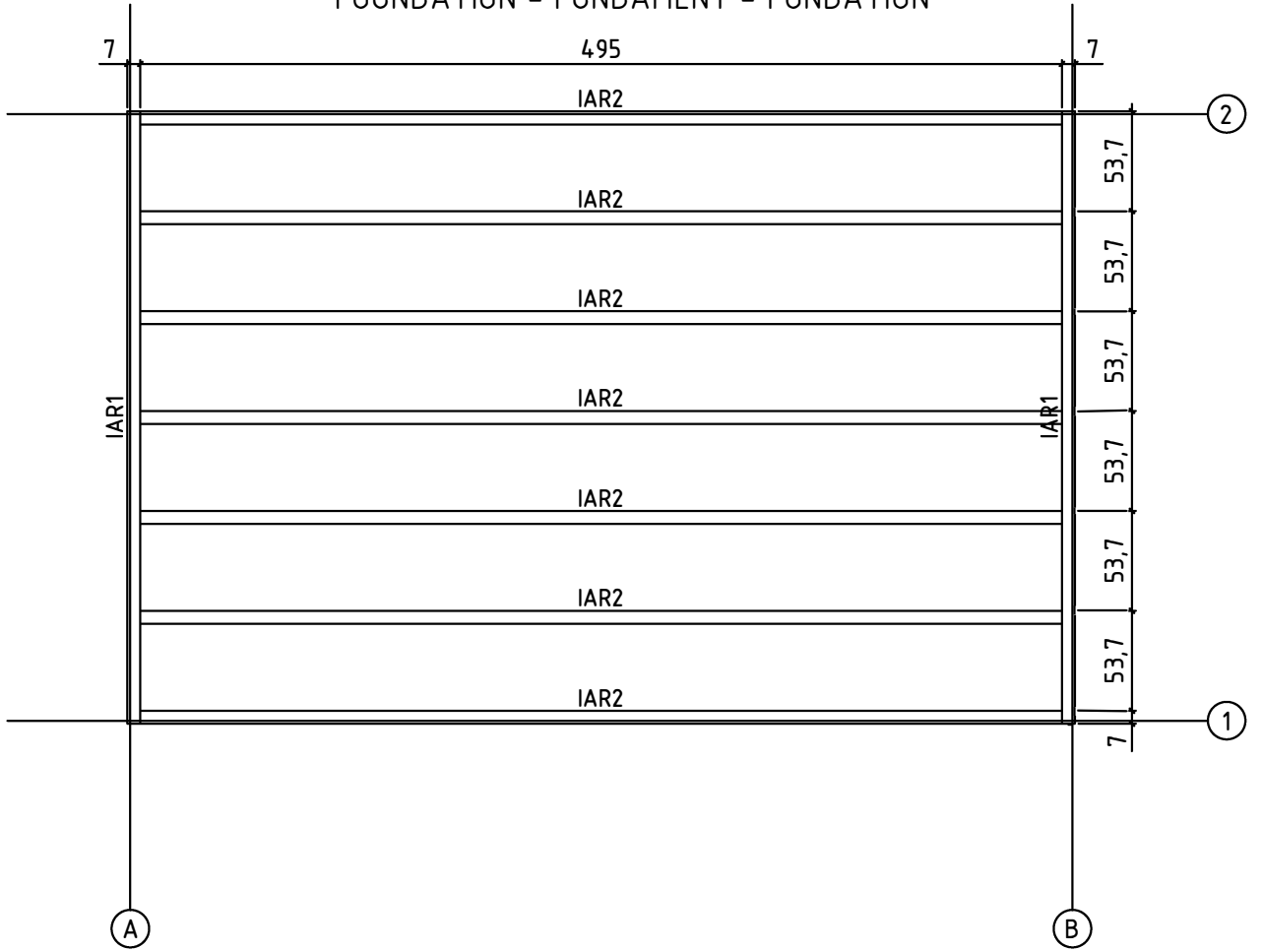



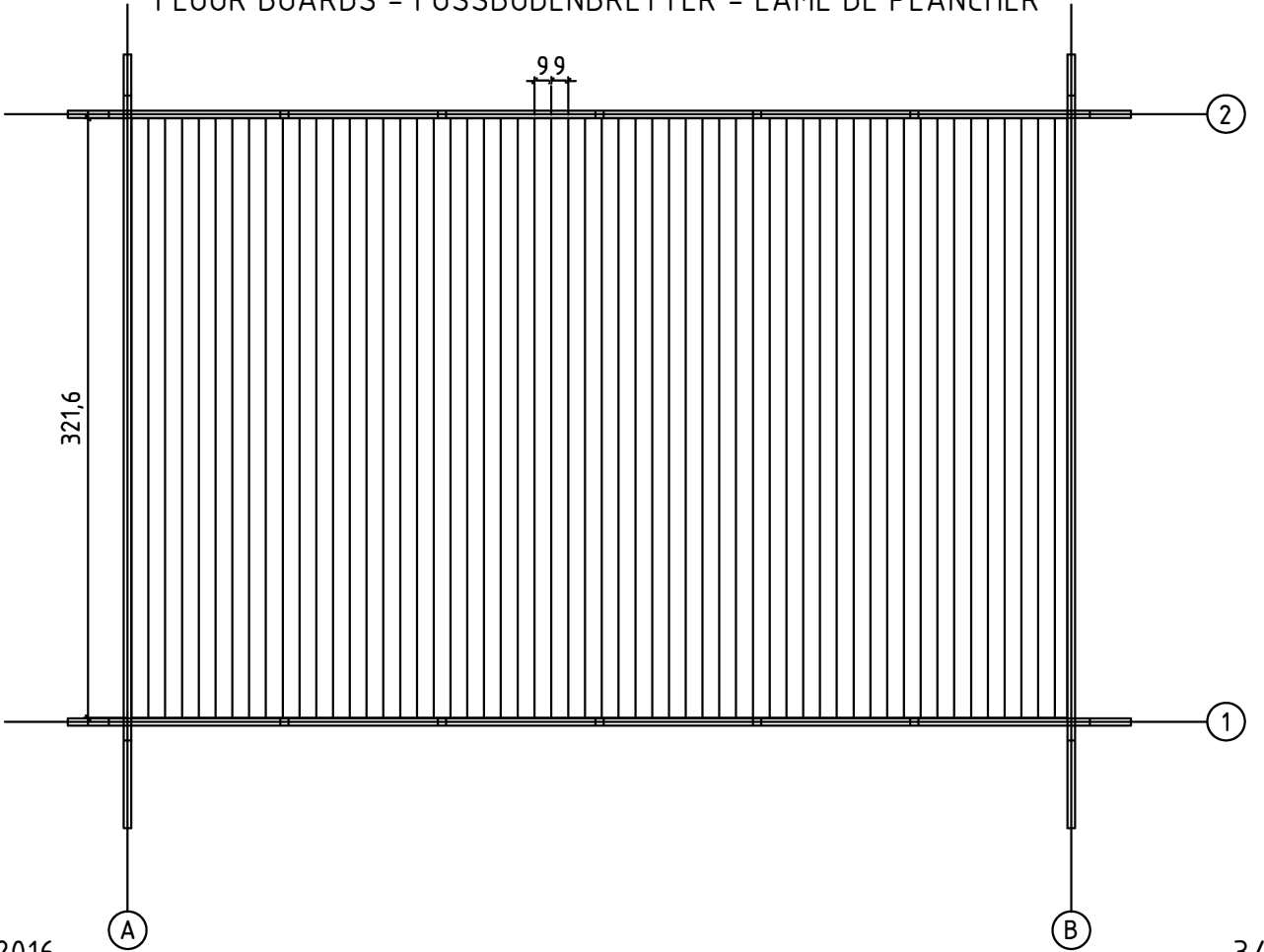

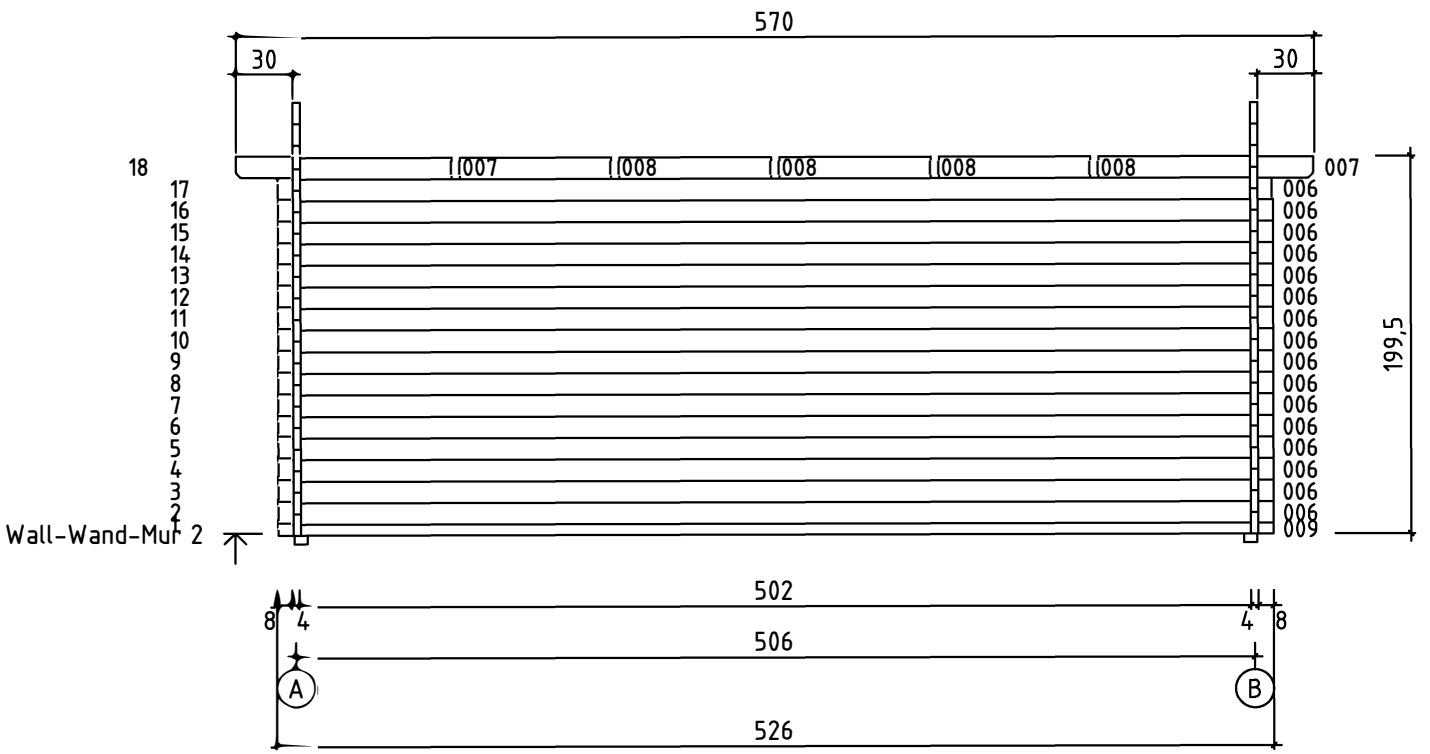
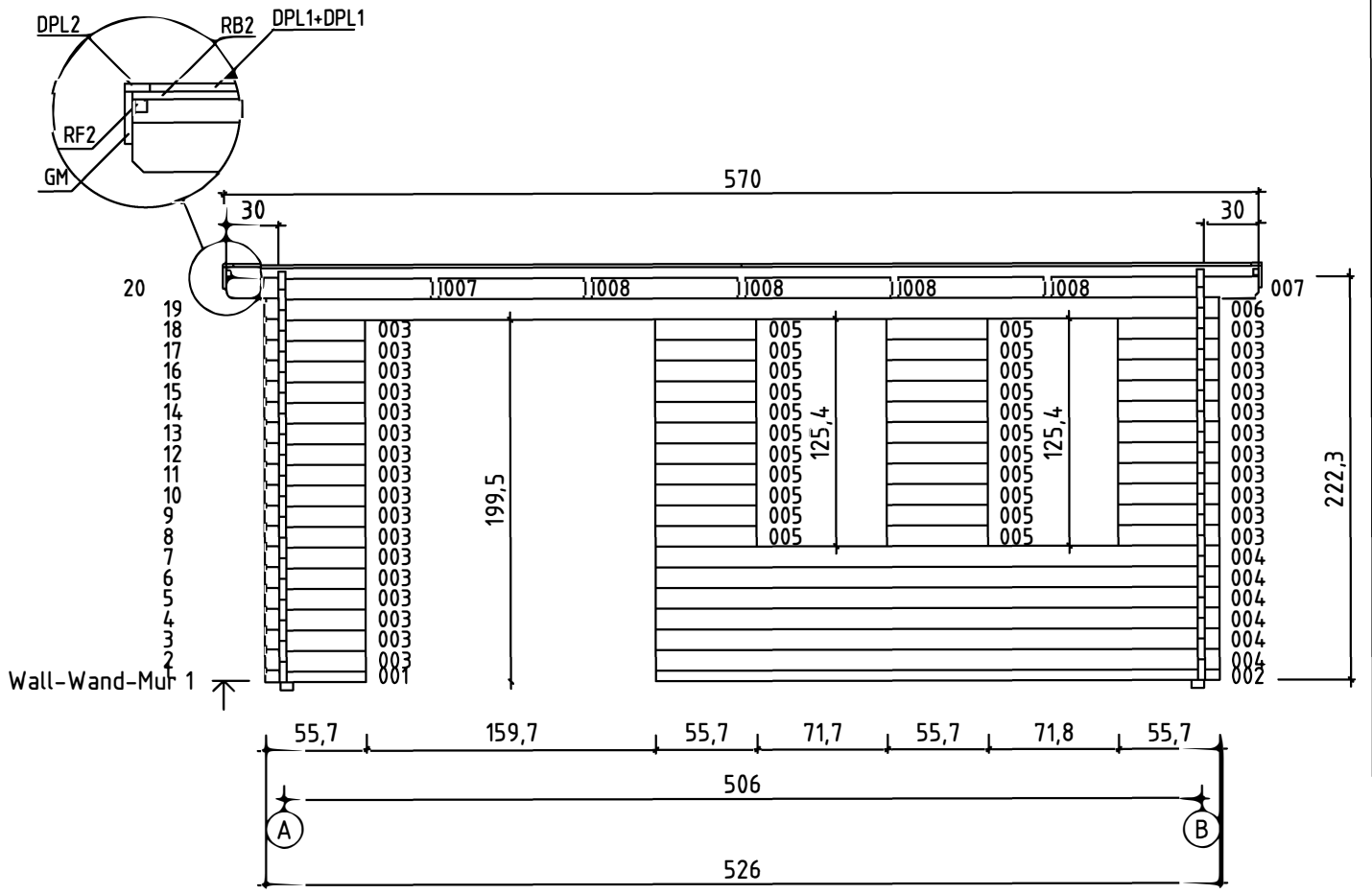

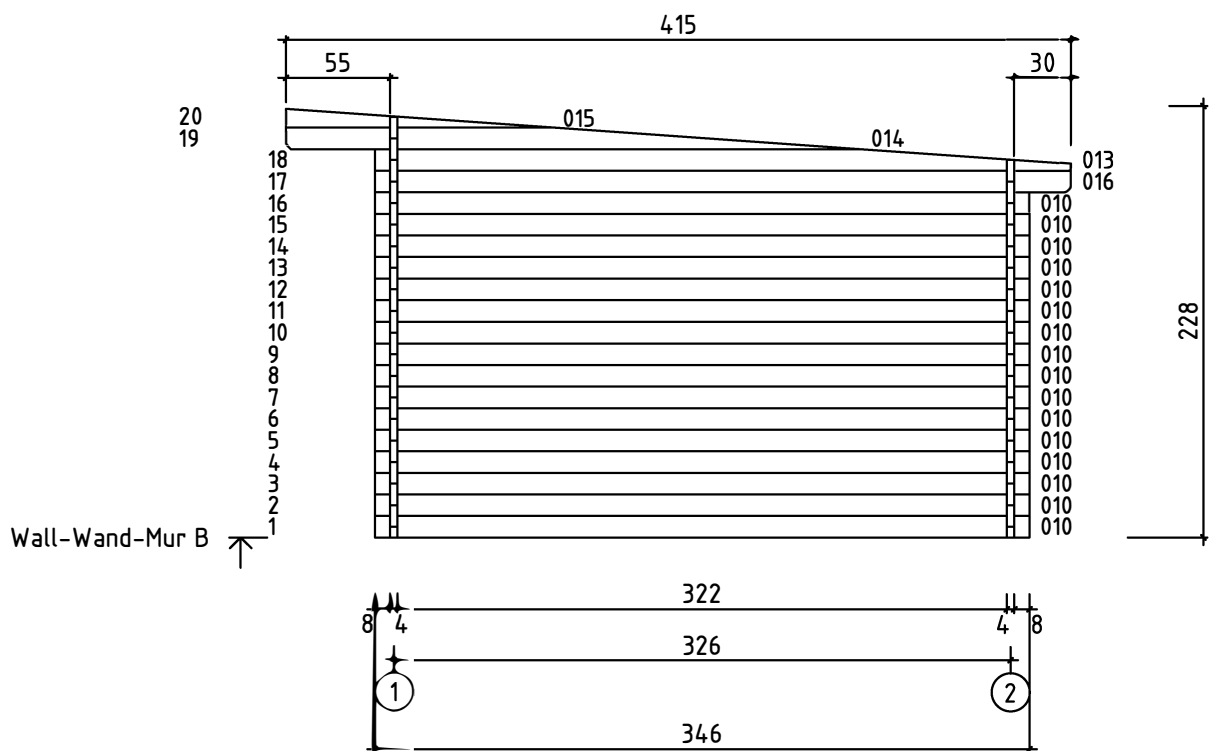
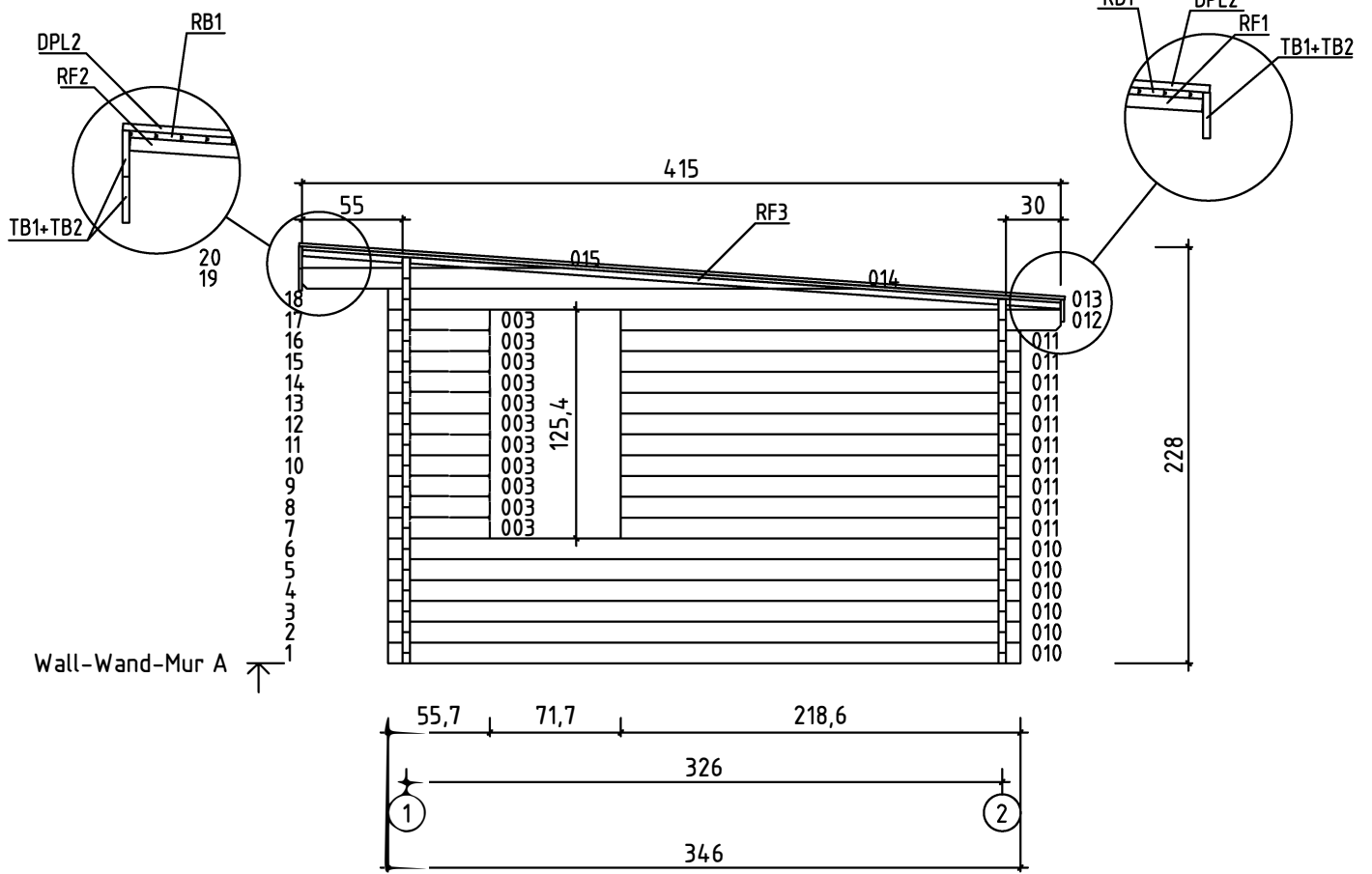

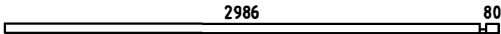

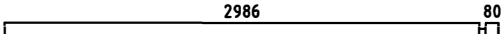

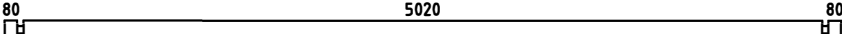
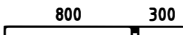
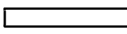
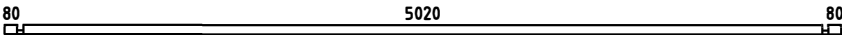
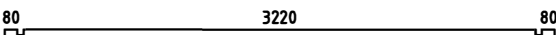
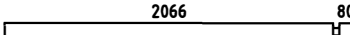
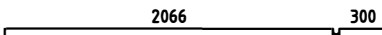
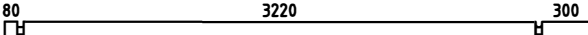
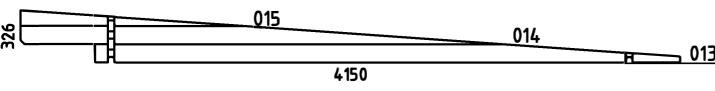
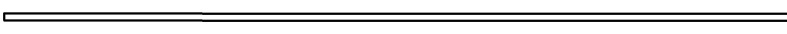
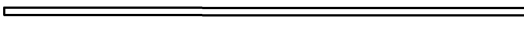
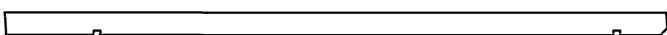

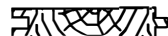



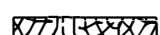
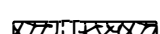





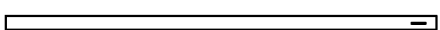
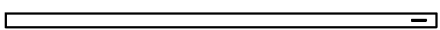
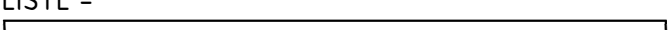
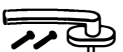





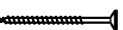

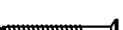
FLOOR BOARDS - FUSSBODENBRETTER - LAME DE PLANCHER









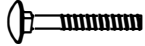

Pos	13.10.2016	Piece list - Stückliste - Liste des pièces	6/8	Q.	P (mm)	L (mm)
001				1	40x57	557
002				1	40x57	3106
003				39	40x114	557
004				6	40x114	3106
005				22	40x114	557
006				17	40x114	5260
007				4	40x114	1140
008				8	40x114	800
009				1	40x57	5260
010				22	40x114	3460
011				10	40x114	2186
012				1	40x114	2406
016				1	40x114	3680
WA-1				1		
WB-1				1		
IAR2	FOUNDATION - FUNDAMENT - FONDATION					
				7	70x45	4950
IAR1	FOUNDATION - FUNDAMENT - FONDATION					
				2	70x45	3290
SR1	RAFTER - DACHSPARREN - CHEVRON					
				5	44x140	4167
	FLOOR BOARDS - FUSSBODENBRETTER - LAME DE PLANCHER			56	90x18	3216
RB1	ROOF BOARDS - DACHBRETTER - VOLIGES			94	90x18	2850
	FLOOR FILLET-FUSSBODENLEISTE - CORNIERE DE FINITION DU PLANCHER				18x18	16.46
DPL1	ROOFING FELT FILLET - DACHPAPPENLEISTE - BAGUETTE DE FIXATION DU FEUTRE BITUMEUX			2	18x58	2810
DPL2	ROOFING FELT FILLET - DACHPAPPENLEISTE - BAGUETTE DE FIXATION DU FEUTRE BITUMEUX			2	18x58	4200
TB1	EAVES BOARD - TRAUFBRETT - BANDEAU DE TOIT			3	18x120	2138
TB2	EAVES BOARD - TRAUFBRETT - BANDEAU DE TOIT			3	18x120	3598

Pos	13.10.2016	Piece list - Stückliste - Liste des pièces	7/8	Q.	P (mm)	L (mm)
RF1	ROOF EDGE REINFORCEMENT - DACHRANDVERSTÄRKUNG - CORNIERE DE RENFORT DE BORD DE TOIT		2	28x34	298	
RF2	ROOF EDGE REINFORCEMENT - DACHRANDVERSTÄRKUNG - CORNIERE DE RENFORT DE BORD DE TOIT		2	28x34	548	
RF3	ROOF EDGE REINFORCEMENT - DACHRANDVERSTÄRKUNG - CORNIERE DE RENFORT DE BORD DE TOIT		2	28x34	3225	
KFS-1	STORM PROTECTION - STURMLEISTE - LATTE ANTI-TEMPETE		2	22x45	2050	
KFS-2	STORM PROTECTION - STURMLEISTE - LATTE ANTI-TEMPETE		2	22x45	2500	
GL	GABLE MOULDING - GIEBELLEISTE - PLANCHE DE RIVE		2	18x120	4168	
FS2	WINDOW HANDLE FITTINGS - FENSTERGRIFF - POIGNÉE D'OUVERTURE DE FENETRE		3	FG10.AL		
HS9	SCREW FOR GABLE MOULDING - SCHRAUBEN FÜR GIEBELLEISTE - VIS DE FIXATION POUR PLANCHE DE RIVE		8	3.5x50		
HS18	SCREW FOR ROOF BEAMS - SCHRAUBEN FÜR DACHBALKEN - VIS POUR PANNE DE TOIT		16	5x120		
HS16	SCREW FOR 1. WALL BEAM - SCHRAUBE FÜR 1. BOHLENREIHE - VIS DE FIXATION DES FONDATIONS		10	5x90		
HS16	SCREW FOR DOOR JAMB - SCHRAUBE FÜR TÜRRAHMEN - VIS DE FIXATION POUR MONTANT DE PORTE		4	5x90		
HS4	SCREW FOR DOOR FILLET - SCHRAUBE ZUR BEFESTIGUNG TÜRLEISTE - VIS D'ASSEMBLAGE DU CADRE DE PORTE		5	3x30		
HS12	SCREW FOR EAVES BOARDS - SCHRAUBEN FÜR TRAUFBRETTER - VIS DE FIXATION POUR BANDEAU DE TOIT		54	4x40		
HS12	SCREW FOR ROOF EDGE REINFORCEMENT - SCHRAUBEN FÜR DACHRANDVERSTÄRKUNG - VIS POUR RENFORT DE BORD DE TOIT		22	4x40		
HS18	SCREW FOR FUNDAMENT - SCHRAUBEN ZUR BEFESTIGUNG FUNDAMENT - VIS POUR FONDATION		14	5x120		
HS18	SCREW FOR GABLE - SCHRAUBEN FÜR GIEBEL - VIS POUR FIXATION DES PIGNONS		16	5x120		
HS23	SCREWS FOR DET. 007, 008 - SCHRAUBEN FÜR Det. 006, 007, 008 - VIS DE FIXATION DET. 007, 008		24	6x180		
NF2	ZN NAIL FOR FLOOR FILLET - ZN NÄGEL FÜR FUSSBODENLEISTE - POINTE POUR CORNIERE DE FINITION DU PLANCHER		34	1.4x40		
TL5	DOOR HANDLE FITTINGS - TÜRGRIFF - SET DE GARNITURES DE SERRURE DE PORTE		1			
SH40	HAMMER BLOCK - SCHLAGHOLZ - CALLE DE FRAPPE		1			
HS25	SCREW FOR DOORSTEP - SCHRAUBEN FÜR SWELLE - VIS DE FIXATION DU SEUIL DE PORTE		3	4.5x65		
	ZN NAIL FOR ROOF - ZN NÄGEL FÜR DACHBRETTER - POINTE POUR TOIT		396	2x50		
NF4	ZN NAIL FOR FLOOR - ZN NÄGEL FÜR FUSSBODENBRETTER - CLOUS POUR PLANCHER		406	2x50		
NF5	ZN NAIL FOR ROOFING FELT FILLET - ZN NÄGEL FÜR DACHPAPPENLEISTE - POINTE POUR BAGUETTE FIXATION FEUTRE BITUMEUX		32	2x40		
	MALE BOLT HINGE FOR DOOR - TÜRRIEGEL - PARTIE MALE DE CHARNIERE DE PORTE		6	14/80		

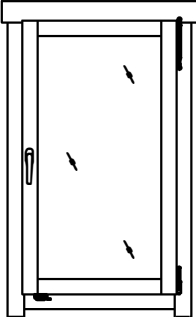
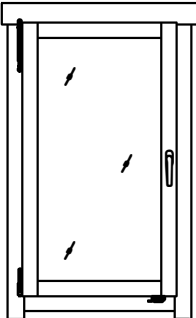
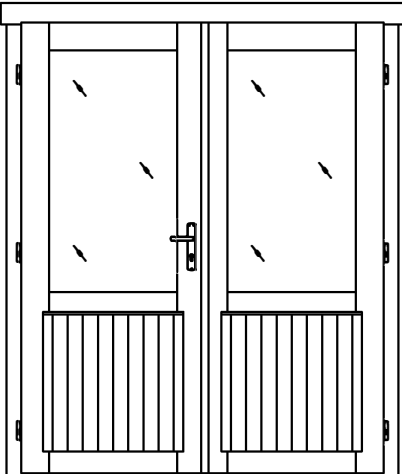
Pos	13.10.2016	Piece list - Stückliste - Liste des pièces	8/8	Q.	P (mm)	L (mm)
SFS		NUT FOR STORM PROTECTION - SCHRAUBENMUTTER FÜR STURMLEISTE - ÉCROU POUR LAME ANTI-TEMPETE		8	D6	
BFS		BOLT FOR STORM PROTECTION - BOLZEN FÜR STURMLEISTE - VIS POUR LAME ANTI-TEMPETE		8	6x70	
DFS		WASHER FOR STORM PROTECTION - DICHTSCHEIBE FÜR STURMLEISTE - RONDELLE POUR LAME ANTI-TEMPETE		8	D6	
TL4		DOOR HANDLE FITTINGS-TÜRGRIFF - SET DE GARNITURES DE SERRURE DE PORTE		1		
		CYLINDER LOCK -ZYLINDERSCHLOSS - CYLINDRE DE SERRURE		1	30/35	
		STRIKER FOR BARREL BOLT - HÜLSE FÜR GRENDDELRIEGEL - GACHE AU SOL DU TARGETTE		2		
		WINDOW - FENSTER - FENETRE 710x1224 DGP+ 	AK.1.100.PSP.e	1		
		WINDOW - FENSTER - FENETRE 710x1224 DGP+ 	AK.1.100.PSV.e	2		
		DOOR - TÜR - PORTE 1588x1957 DGP+ 	TUK.2.060.PVV.MMW	1		