

**DANCOVER<sup>®</sup>**

**.com**

Manual  
for  
Greenhouse  
0,58x1,3x1,4m

# **Greenhouse**

## **Assembly Instructions**

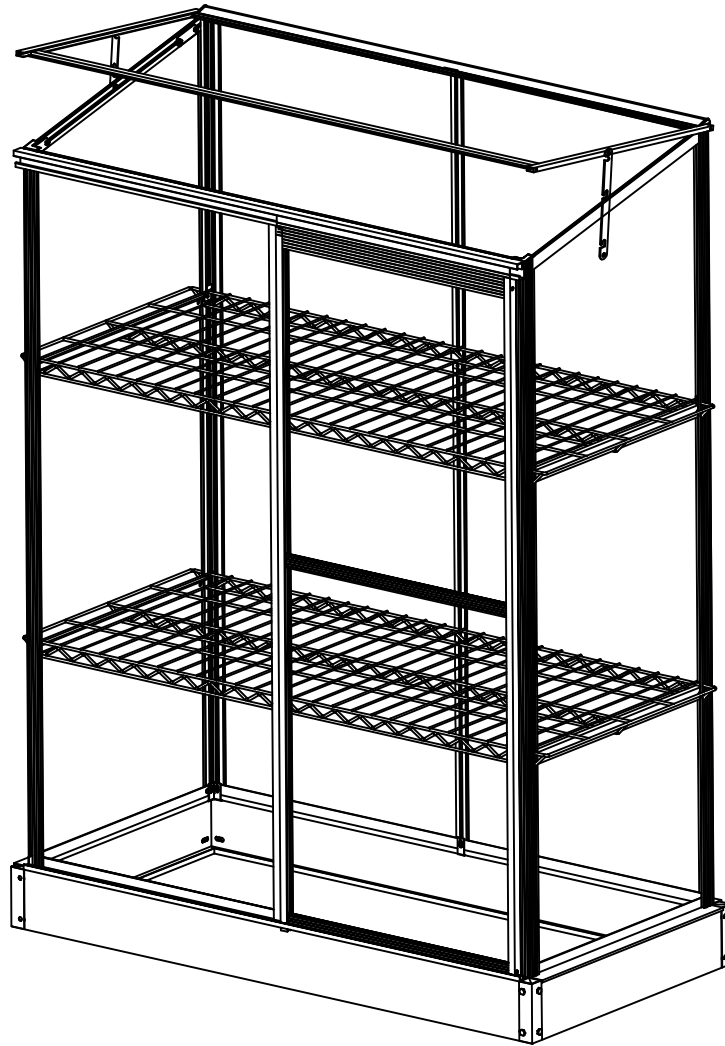

### **IMPORTANT**

You must read these instructions carefully before you start to assemble this greenhouse.

Please ensure that you find all parts in the carton box in the correct type and quantity as mentioned in the list illustrated in every page accordingly.

Please carry out the steps in the order set out in these instructions.

Do not tighten the steps in the greenhouse until completing on the assembly of the polycarbonate panels.

Keep these instructions in a safe place for future reference.

## **SAFETY ADVICE**

We strongly recommend the use of work gloves during assembly.

Do not attempt to assemble the greenhouse in windy or wet conditions,

Do not touch overhead power cables with the aluminum profiles.

Always wear shoes and safety goggles when working with extruded aluminum.

Dispose of all plastic bags safety-keep them out of reach of small children.

The greenhouse must be positioned and fixed on a flat level surface.

Do not lean against or push the greenhouse during construction.

Keep children away from the assemble area.

Do not position your greenhouse in an area exposed to excessive wind.

Do not attempt to assemble this greenhouse if you are tired ,have taken drugs or alcohol or if you are prone to dizzy spells.

If using a step ladder or power tools ensure that you follow the manufactures safety advice.

Hot items such as recently used grills, blowtorches etc.must not be stores in the greenhouse.

Ensure there are no hidden pipes or cables in the ground before inserting the pegs.

## **GENERAL ADVICE**

This is a multi-part assembly, Allow at least 30 minutes for assembly.

Selecting a site-choose a sunny level position away from overhanging trees.

If you are fixing your greenhouse directly to a solid concrete foundation use the pre drilled holes in the metal base supplied.

The component parts should be checked and laid out close at hand.

Keep all small parts(screws etc)in a bowl so they do not get lost.

Note that the door is hinged on the right hand side and therefore opens to the right. Keep roof clear of snow and leaves.

## **CARE & MAINTENANCE**

When your greenhouse needs a clean, use a mild detergent solution and risen with cols clean water.

Do NOT use acetone, abrasive cleaners or other special detergents to clean the clear panels.





## **TOOLS & EQUIPMENT REQUIRED**

Tape measure , large hammer , scissors ,





Work gloves , Drill , spirit level Lubricant , see over for cantents plastic or rubber mallet 0.08" metal drill bit.

If help is required seek professional advise within store.

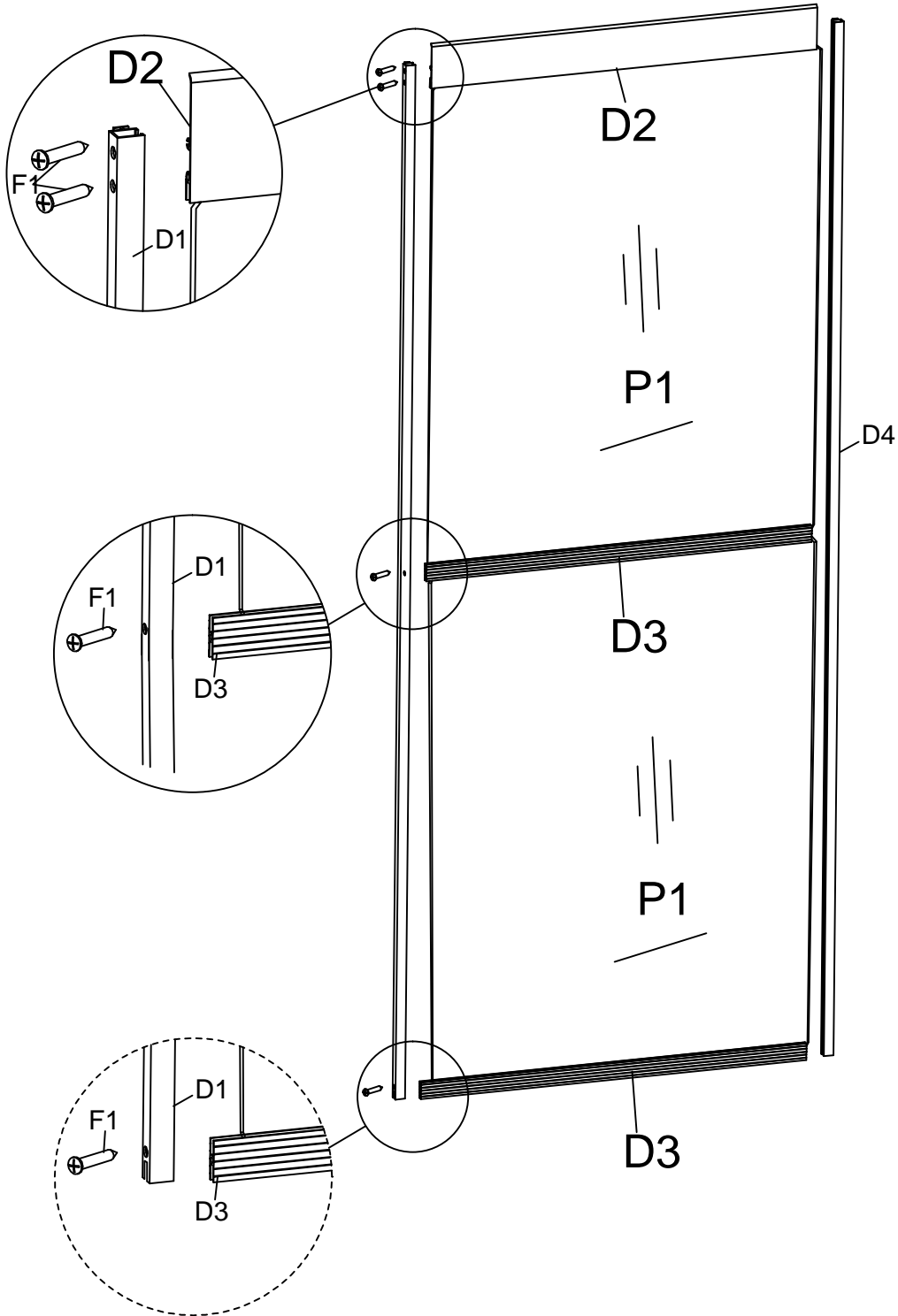
# DOOR

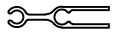
PART	NO.	Qty.
	D1	1
	D4	1
	D2	1
	D3	2
	F1	8

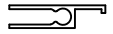

PART	NO.	Qty.
	W1	1
	W2	2
	W3	1
	P2	1
	F2	6

## WINDOW

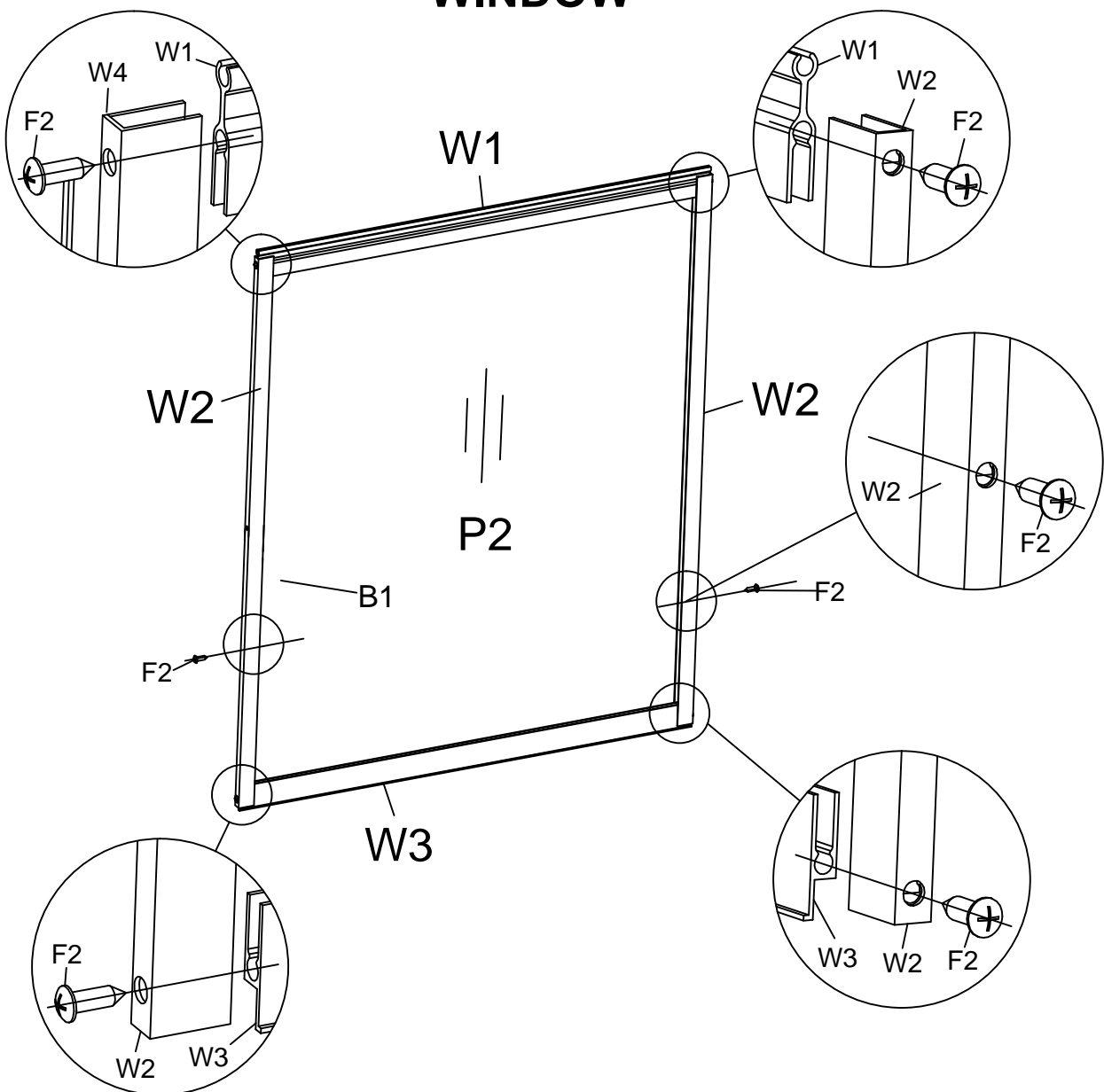

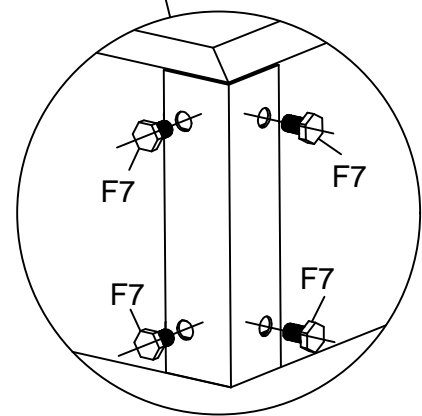
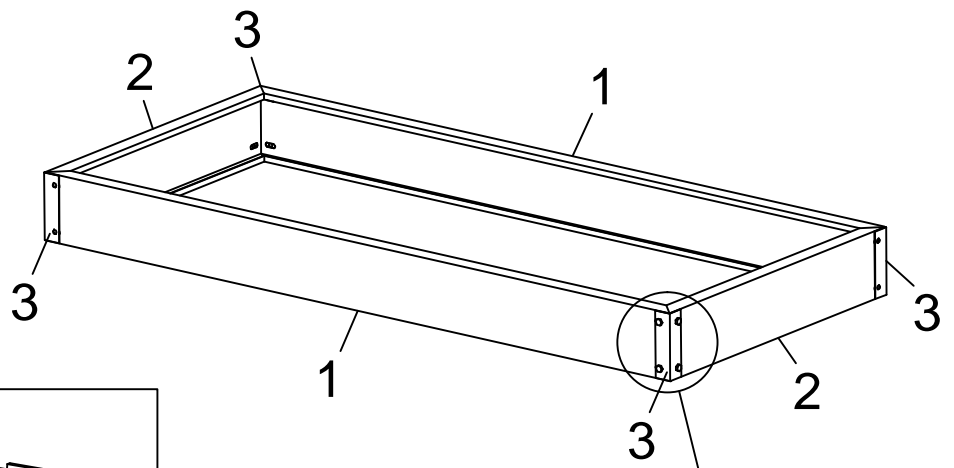



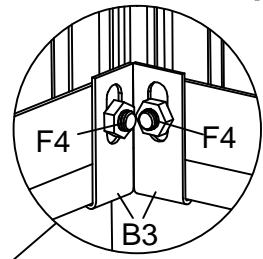
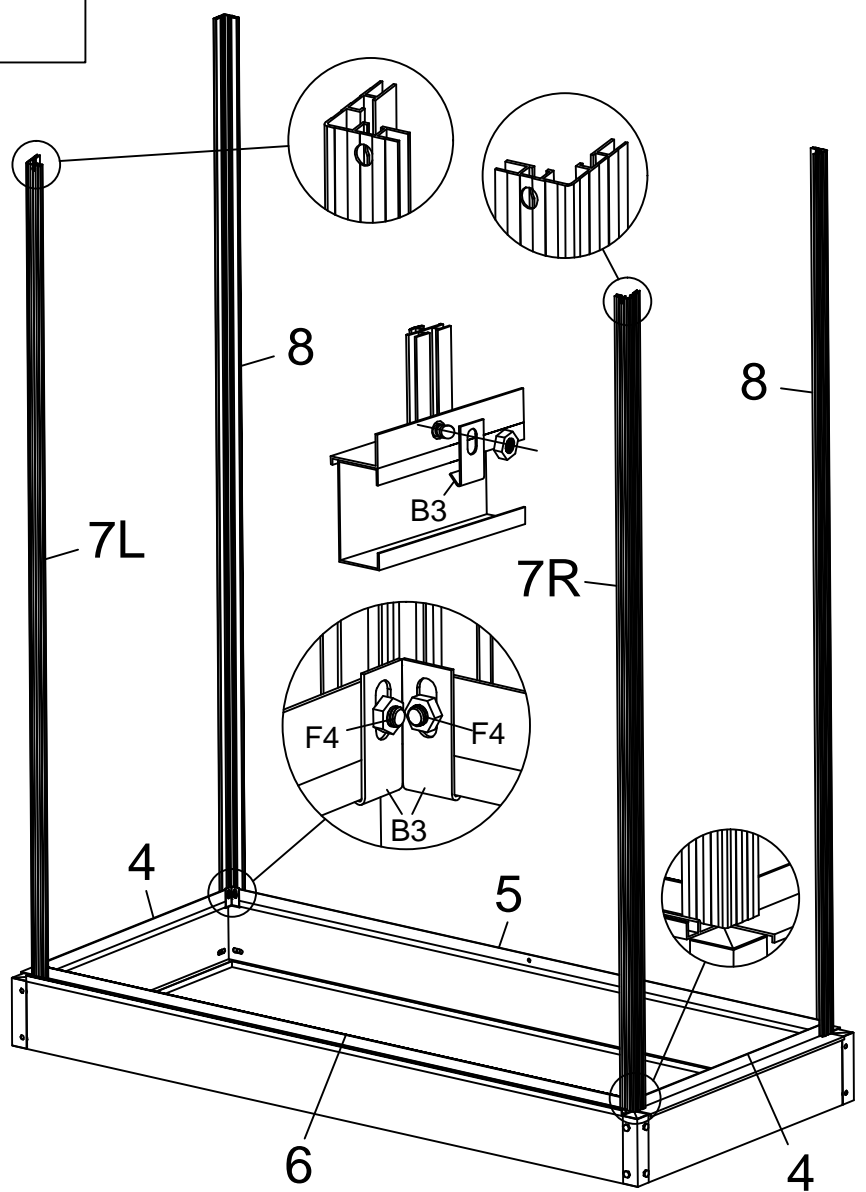

**"hexagonalscrew" installation**



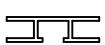



Place the "hexagonalscrew" into the groove, turn clock wise until its to turning. Adjust the "hexagonalscrew" by hand and twist threads fix it in place. Place other part on "hexagonalscrew" and assemble nut.

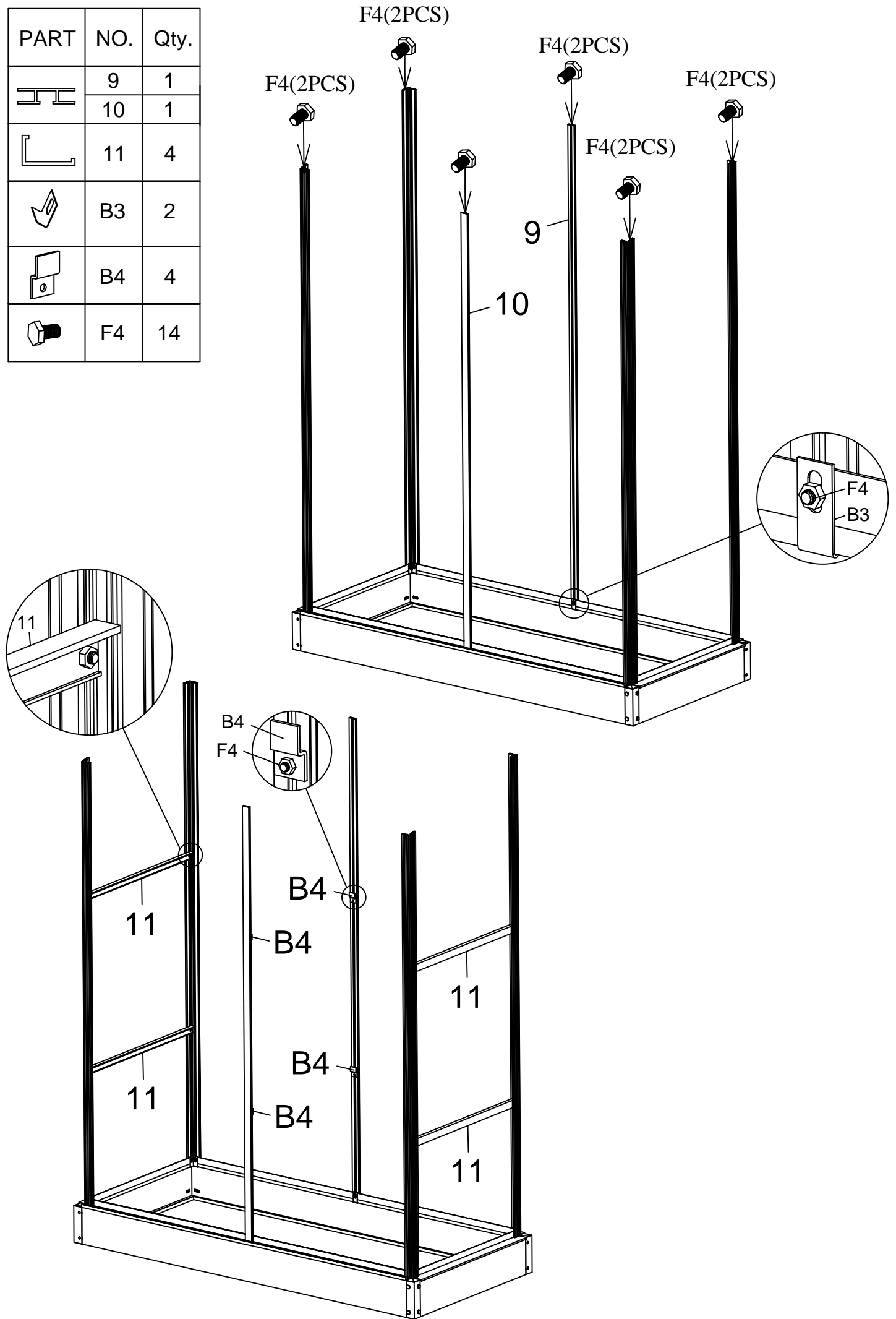

PART	NO.	Qty.
	1	2
	2	2
	3	4
	4	2
	5	1
	6	1
	7R	1
	7L	1
	8	2
	B3	8
	F7	16
	F4	8

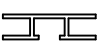

PART	NO.	Qty.
	9	1
	10	1
	11	4
	B3	2
	B4	4
	F4	14

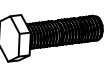

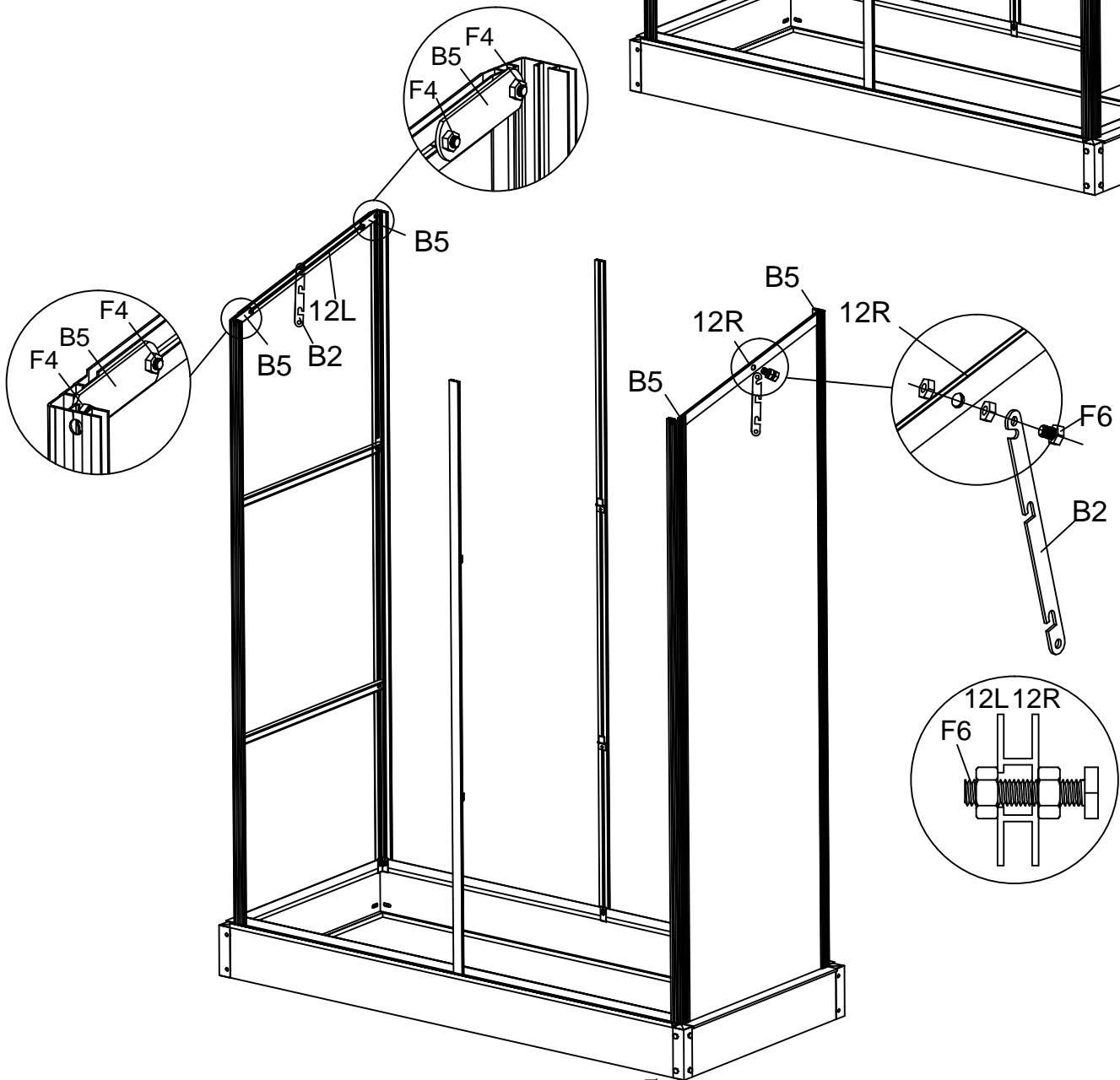
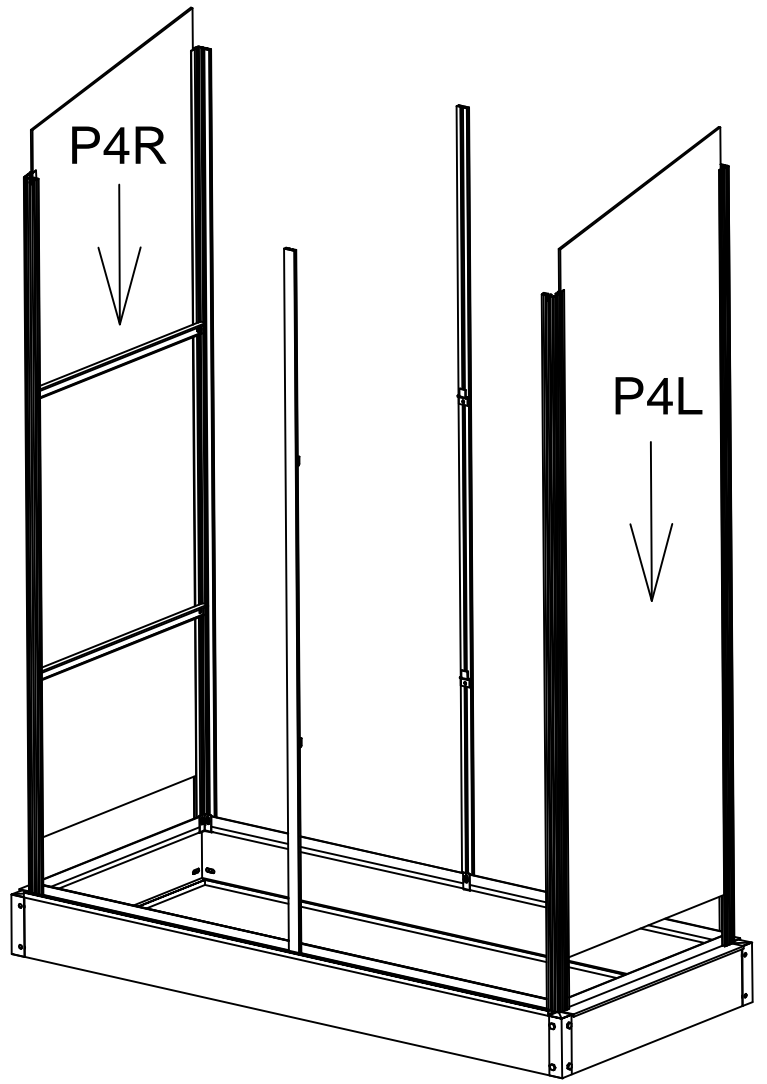





PART	NO.	Qty.
	P4R	1
	P4L	1
	12R	1
	12L	1
	B5	4
	B2	2
	F4	8
	F6	2

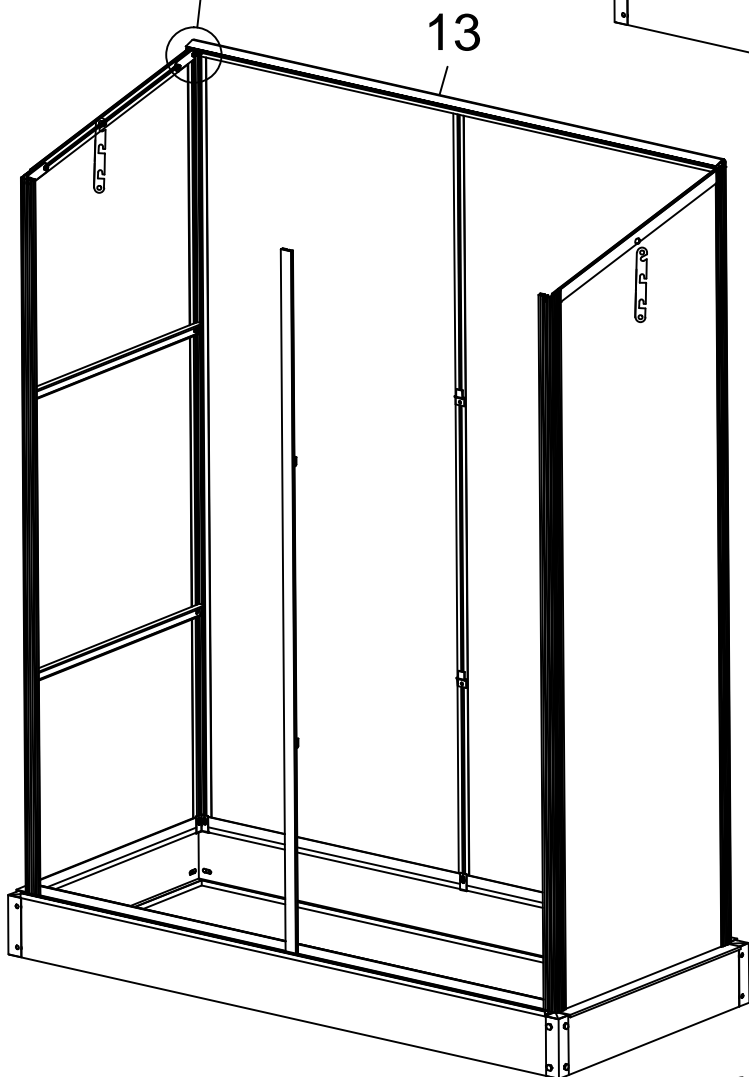
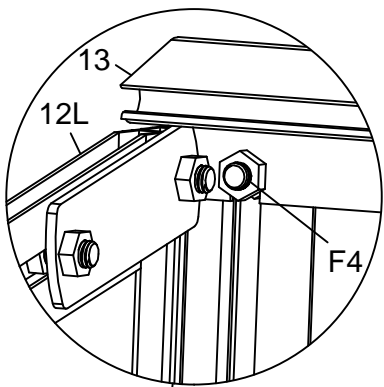
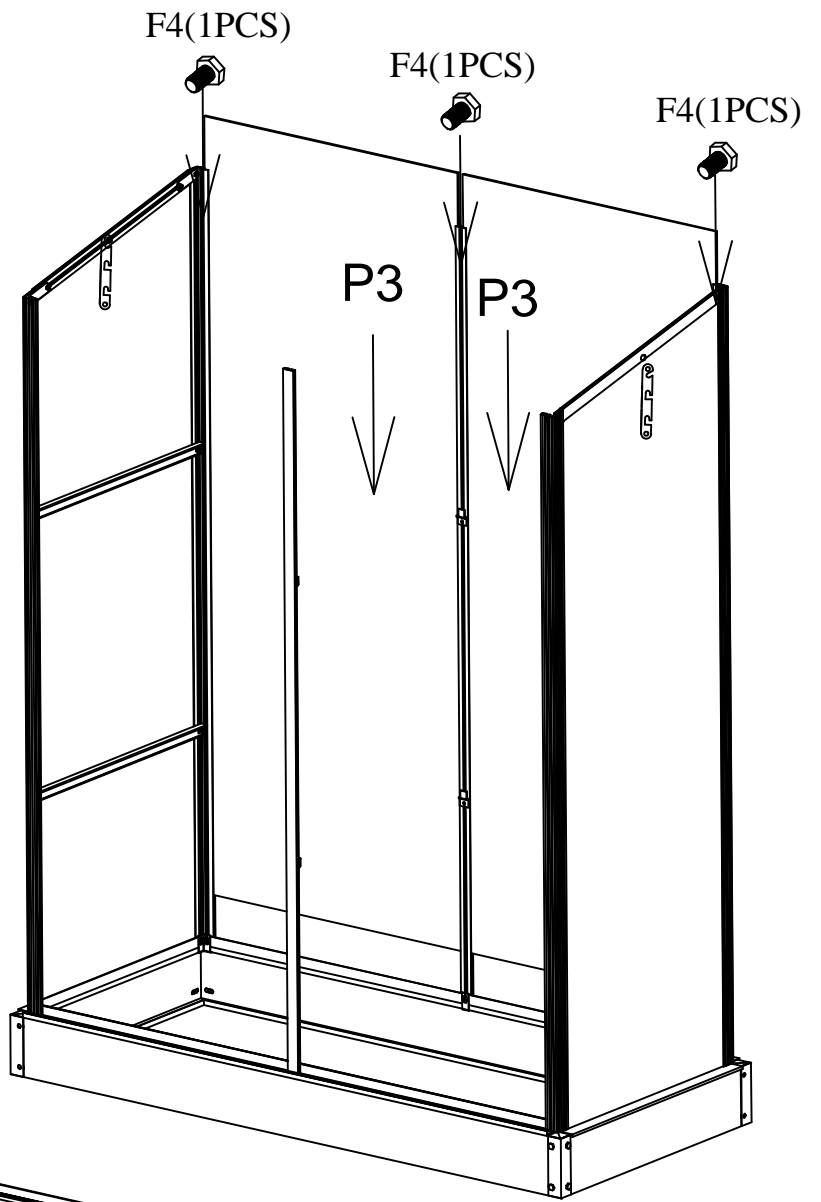



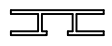

PART	NO.	Qty.
	P3	2
	13	1
	F4	3



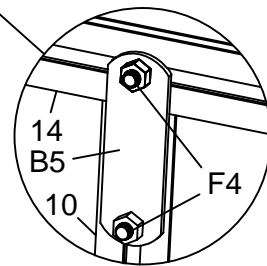
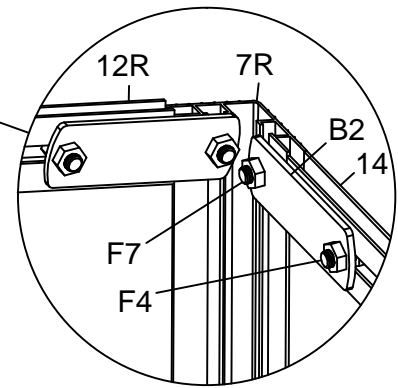
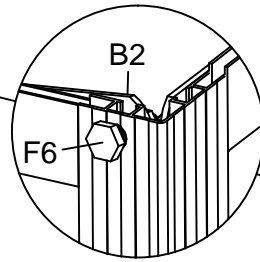
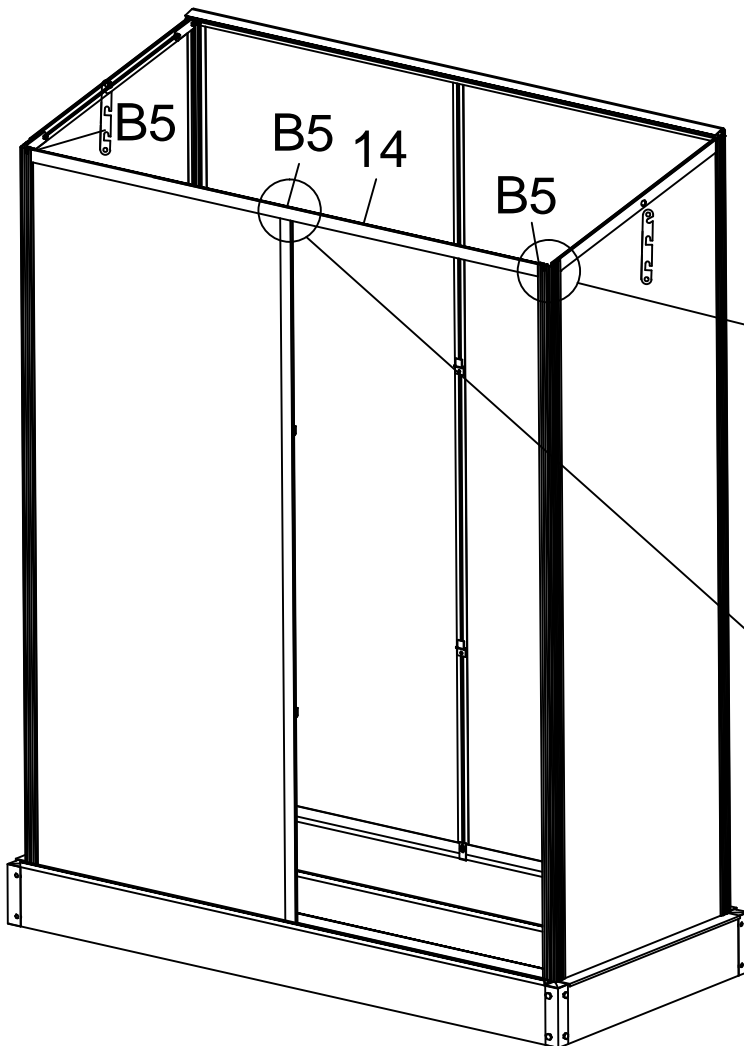
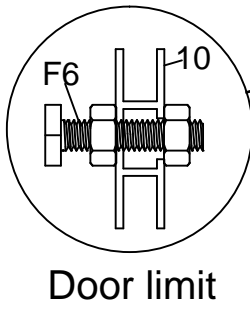
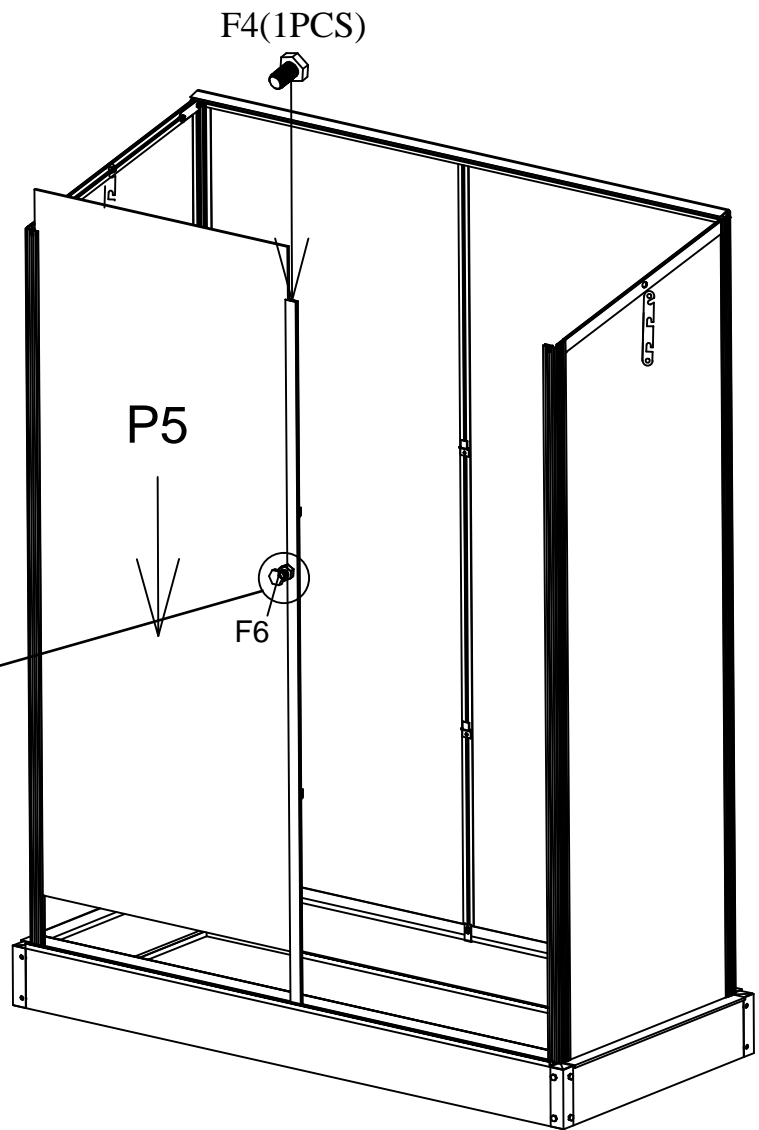



PART	NO.	Qty.
	P5	1
	14	1
	B5	3
	F4	5
	F6	3

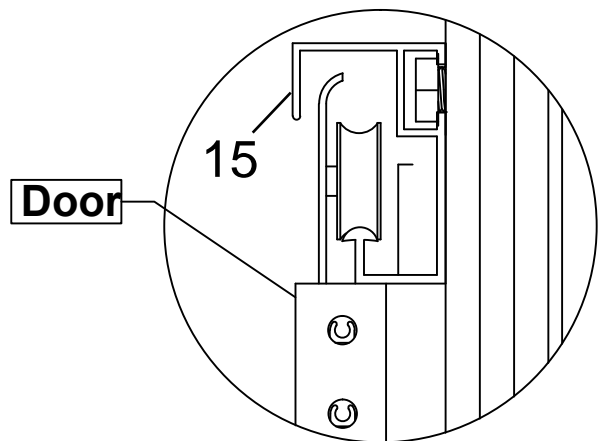
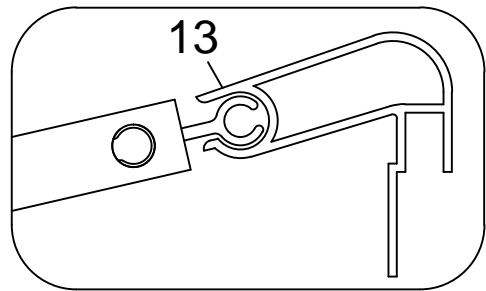
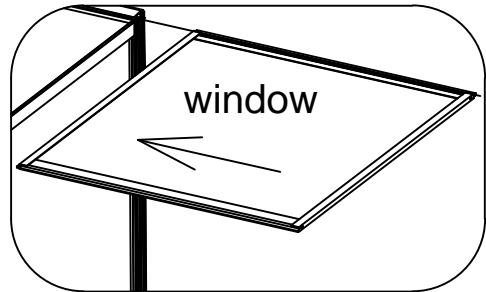
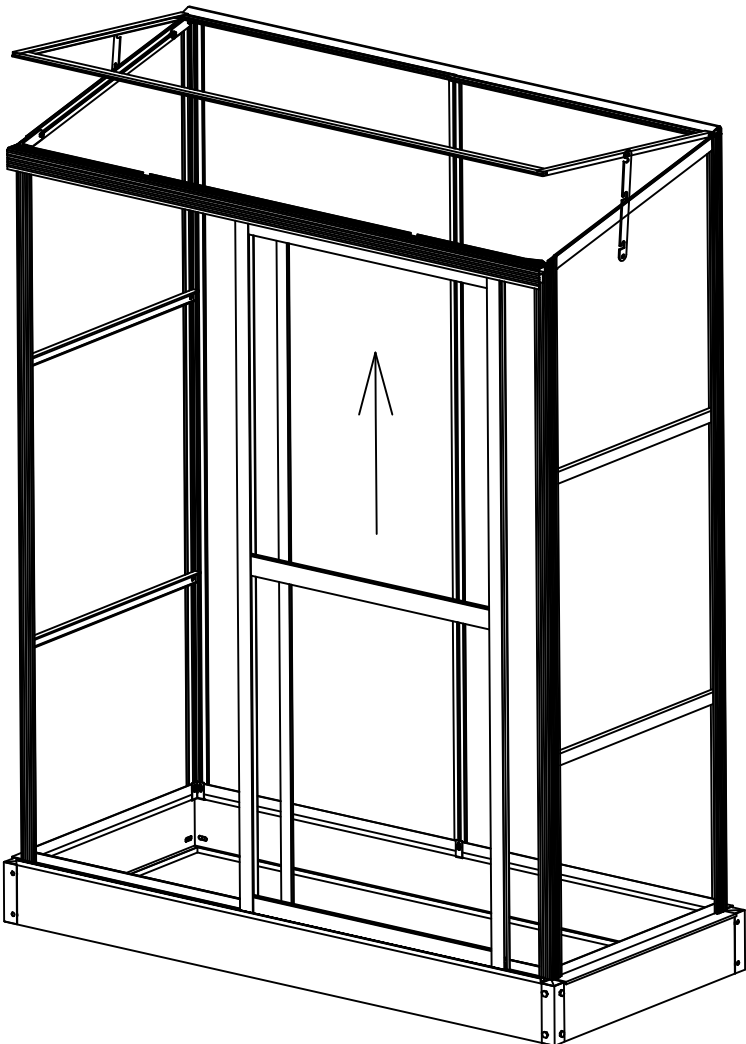
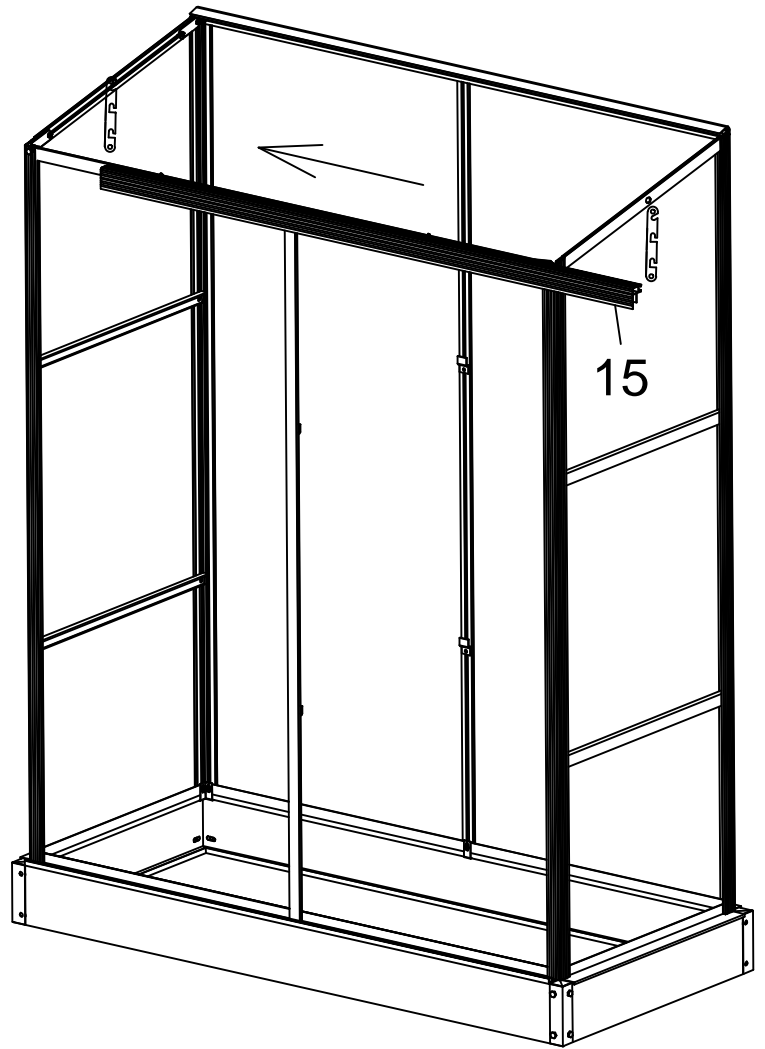
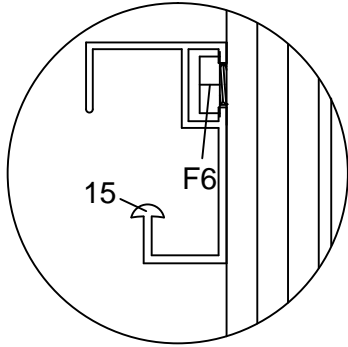



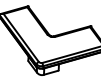

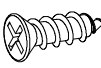

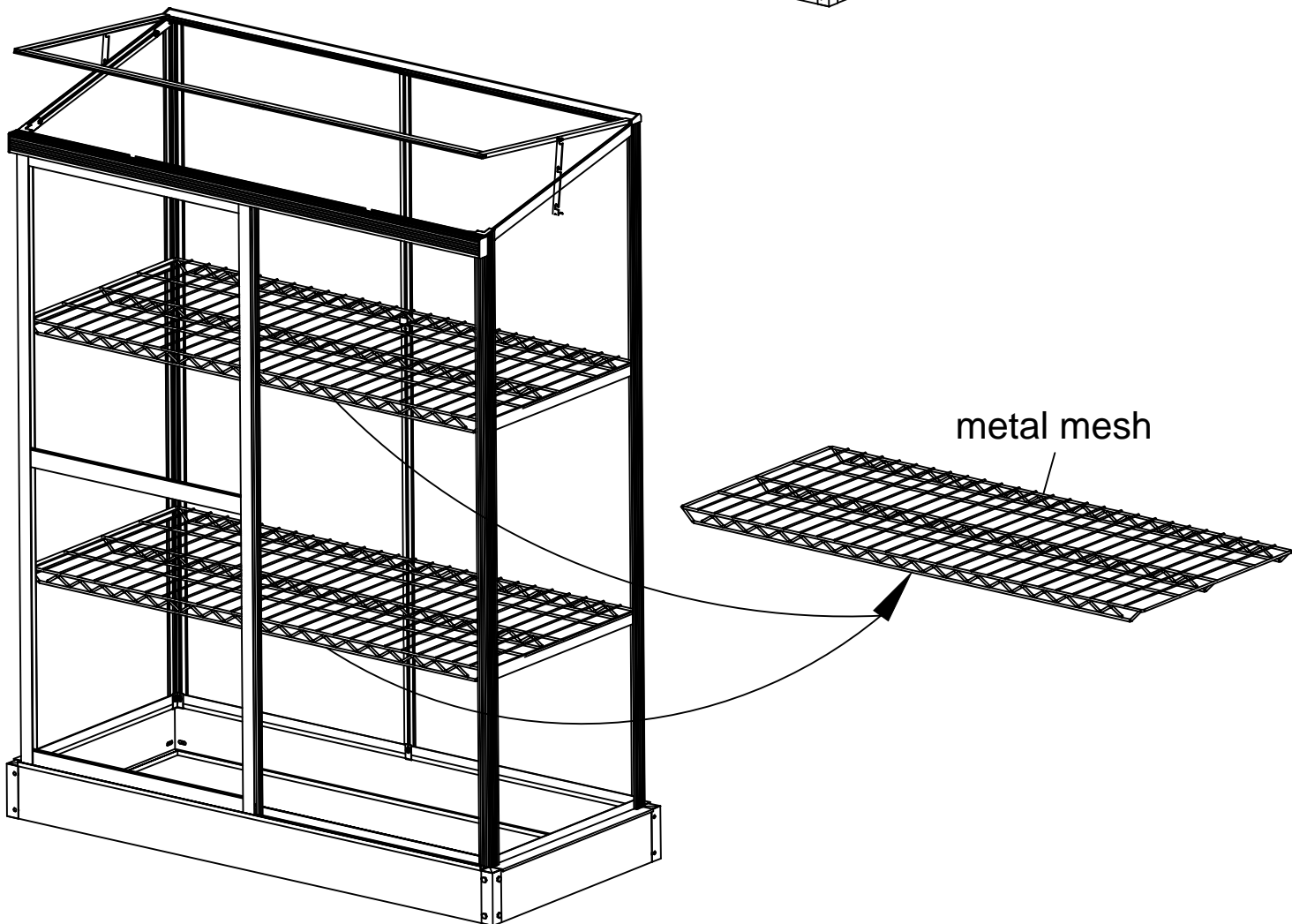
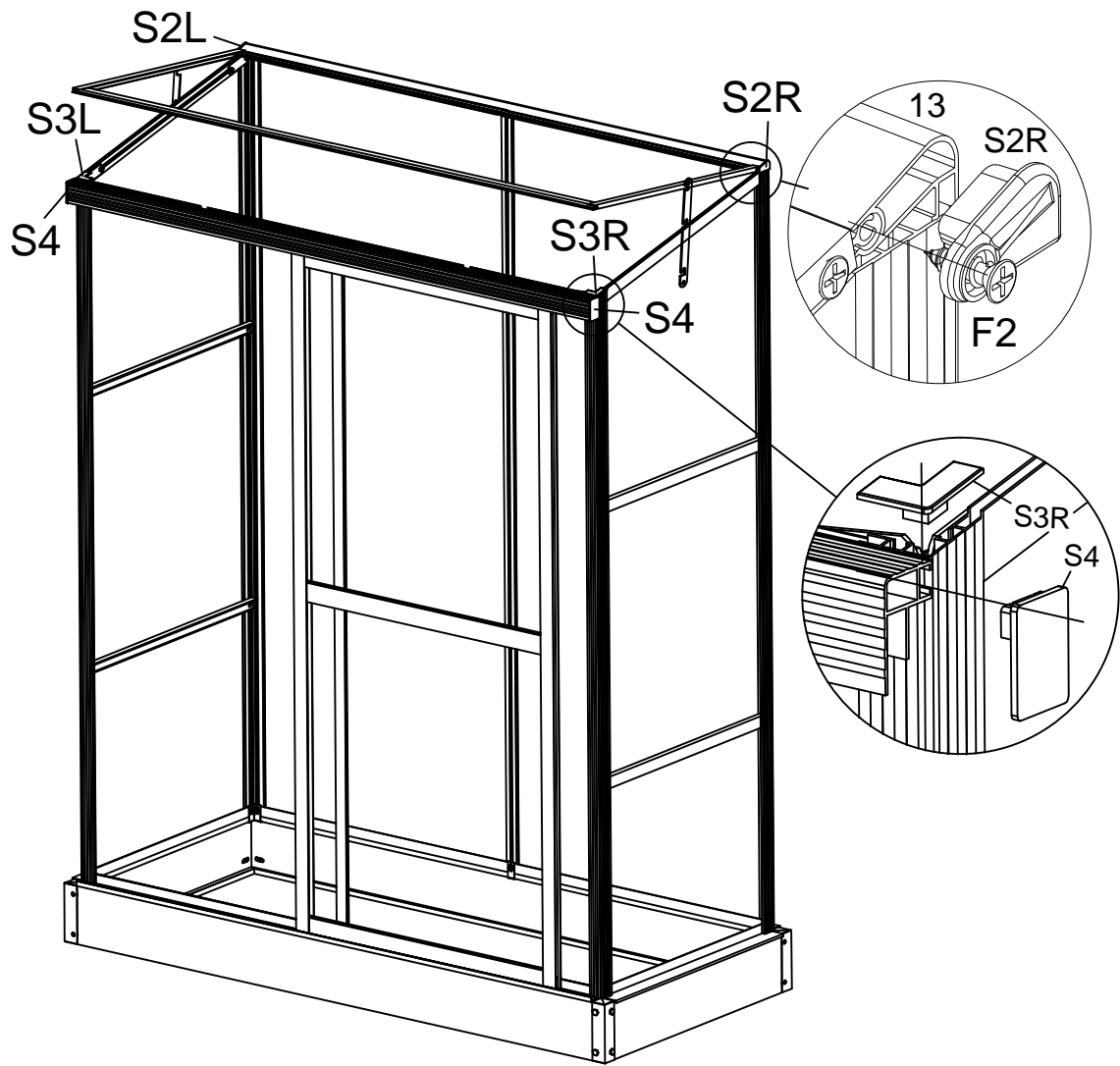
PART	NO.	Qty.
	15	1





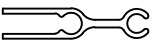
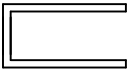

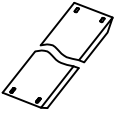

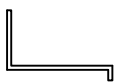
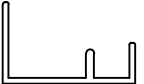
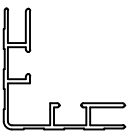
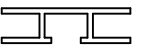

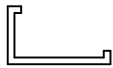

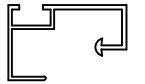
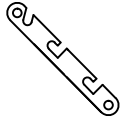

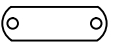
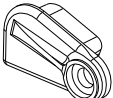
PART	NO.	Qty.
	S2L	1
	S2R	1
	S3R	1
	S3L	1
	S4	2
	F2	2

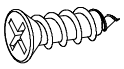

## PART LIST

PART	NO.	Qty.
	D1	1
	D4	1
	D2	1
	D3	2
	W1	1
	W2	2
	W3	1
	1	2
	2	2
	3	4
	4	2
	5	1
	6	1
	7R	1
	7L	1
	8	2
	9	1
	10	1
	12R	1
	12L	1
	14	1

PART	NO.	Qty.
	11	4
	13	1
	15	1
	B2	2
	B3	10
	B4	4
	B5	7
	S2L	1
	S2R	1
	S3R	1
	S3L	1
	S4	2
	F1	8
	F2	8

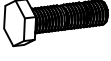
PART	NO.	Qty.
	F7	16
	F4	38
	F6	5

PC	P1	2
	P2	1
	P3	2
	P4R	1
	P4L	1
	P5	1

# DANCOVER<sup>®</sup>

.com

## Contact information

### Head office:

Dancover A/S  
Nordre Strandvej 119 G  
3150 Hellebæk  
Denmark

For more information  
please visit:  
[www.dancovershop.com](http://www.dancovershop.com)

## National contact

Denmark: 70 26 76 20  
[denmark@dancover.com](mailto:denmark@dancover.com)

UK: 020 8099 7570  
[uk@dancover.com](mailto:uk@dancover.com)

Germany: 041 0266 7040  
[germany@dancover.com](mailto:germany@dancover.com)

France: 0975 181 800  
[france@dancover.com](mailto:france@dancover.com)

Sweden: 040 233 262  
[sverige@dancover.com](mailto:sverige@dancover.com)

Finland: 0 931 581 720  
[suomi@dancover.com](mailto:suomi@dancover.com)

Poland: 22 300 8602  
[polska@dancover.com](mailto:polska@dancover.com)

Luxembourg: +49 041 0266 7040  
[luxembourg@dancover.com](mailto:luxembourg@dancover.com)

Portugal: 308 800 899  
[portugal@dancover.com](mailto:portugal@dancover.com)

Spain: 911 436 828  
[espana@dancover.com](mailto:espana@dancover.com)

Italy: 02 479 21 198  
[italia@dancover.com](mailto:italia@dancover.com)

Switzerland: 0840 000125  
[schweiz@dancover.com](mailto:schweiz@dancover.com)

Austria: 0662 626935  
[austria@dancover.com](mailto:austria@dancover.com)

Norway: 231 00 690  
[norge@dancover.com](mailto:norge@dancover.com)

Nederland: 0 858 880 524  
[nederland@dancover.com](mailto:nederland@dancover.com)

Ireland: 0 151 33 003  
[ireland@dancover.com](mailto:ireland@dancover.com)

Belgium: 0 28 08 08 09  
[belgique@dancover.com](mailto:belgique@dancover.com)