

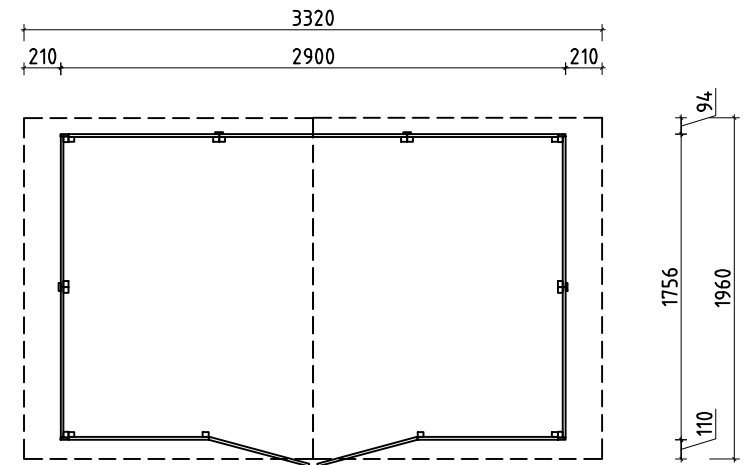

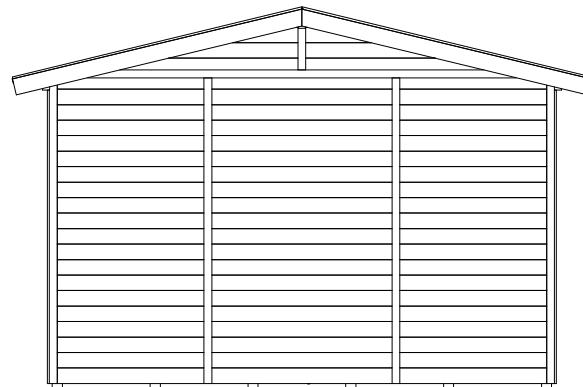

Name Sven 290X175.6; 16

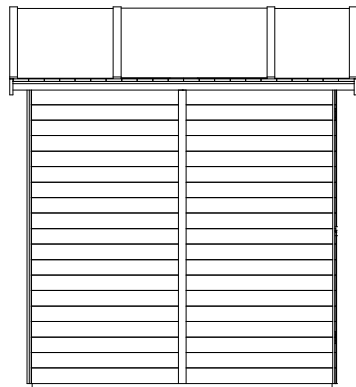

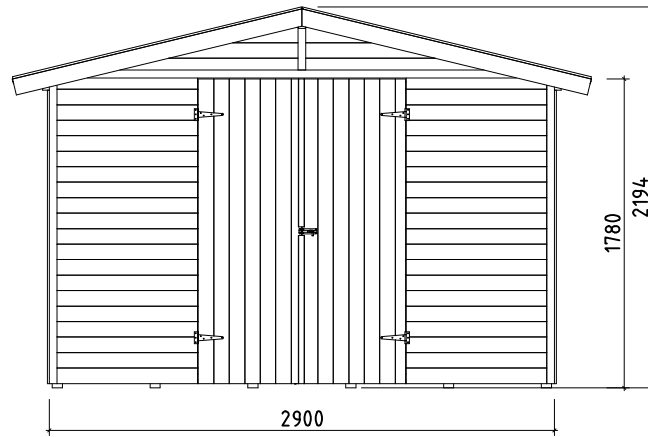
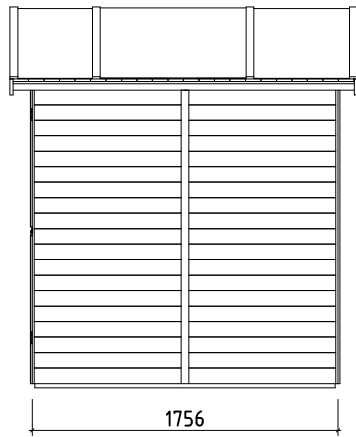

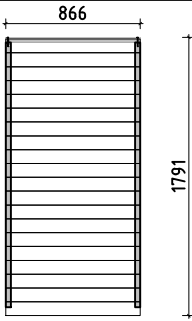
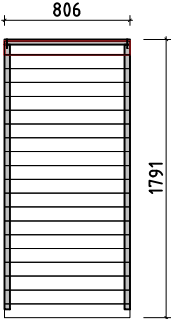
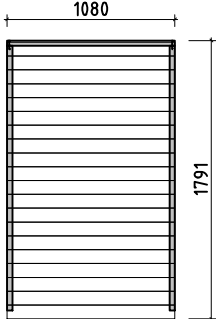
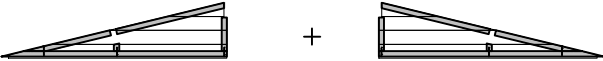
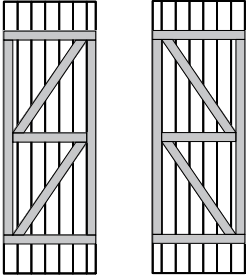





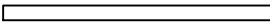

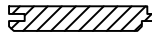







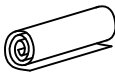

Zeichnung/Drawing 3D

Profil/Profile 1.6X8.9 Datum/Date 07.03.2023



Name	Sven 290x175.6; 16		
Zeichnung/Drawing	Grundplan, Plan		
Profil/Profile	1.6x8.9	Datum/Date	07.03.2023

Pos	Teileliste/Specification Sven 290x175.6; 16	Stck. Pcs.	Profil Profile (mm)	Länge Length (mm)
EL1		6	866x1791	
EL2		2	806x1791	
EL3		1	1080x1791	
EL4 EL5		2+2	1450x356	
Doors		1+1	593x1750	
LT7	 LATTEN - STUDS	1	34x28	1080
LT5	 LATTEN - STUDS	6	34x28	866
LT6	 LATTEN - STUDS	2	34x28	806
FH1	 FUNDAMENTHÖLZER (imprägniert)	6	58x28	1724
Kood	Sven 290x175.6; 16	Materjal		Leht 1/3

Pos	Teileliste/Specification Sven 290x175.6; 16		Stck. Pcs.	Profil Profile (mm)	Länge Length (mm)	
PF1	PFETTEN - PURLINS 		3	40x95	1960	
PF2	PFETTEN - PURLINS 		2	40x95	1724	
UPL1	Windleiste - Wind slat 		2	35x10	850	
	DACHBRETTER - ROOF BOARDS		46+1 36+1	89x16 113x16	1708	
	FUSSBODENBRETTER - FLOOR BOARDS		20+1 16+1	89x16 113x16	2863	
G01-1	GIEBELBRETTER - GABLE BOARDS 18x95	13.6° 	✓	4	18x95	1710
LE7	LEISTE - LATH 		✓	2	45x12	2902
LE5	LEISTE - LATH 		✓	2	45x12	1960
LE3	LEISTE - LATH 		✓	4	45x12	1801
LE1	LEISTE - LATH 		✓	2	45x12	1757
LE6	LEISTE - LATH 		✓	8	45x12	1708
LE2	LEISTE - LATH 		✓	2	45x12	1686
LE4	LEISTE - LATH 		✓	2	45x12	240
LT11	LATTEN - STUDS 		✓	1	58x28	1200
KP-1	DACHPAPPE - ROOFING FELT		✓		3,55m-3'st	10,65jm
NG02	NÄGEL - NAILS 2.0x40 Fussbodenbretter - Floor boards		240			
NG2 550	NÄGEL - NAILS 2.5x50 Dachbretter - Roof boards		276			
SR30	Schrauben - Screws 3.0x20 Windleiste - Wind slat		6			
SR32	Schrauben - Screws 3.0x30 Riegel - Latch 03		6			
SR35	Schrauben - Screws 3.5x25 LE5		8			
SR35	Schrauben - Screws 3.5x25 LE1, LE2, LE3		32			
SR35	Schrauben - Screws 3.5x25 LE4, LE7		16			
SR35	Schrauben - Screws 3.5x25 LE6		32			
SR3 545	Schrauben - Screws 3.5x45 Giebelbretter - Gable boards		16			
SR4 030	Schrauben - Screws 4.0x30 T-Scharnier - T-Hinge		28			
Kood	Sven 290x175.6; 16		Materjal		Leht 2/3	

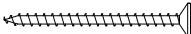
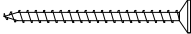
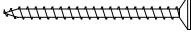
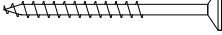
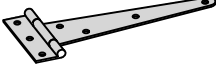
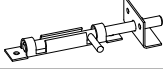
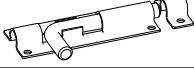
Pos	Teileliste/Specification Sven 290x175.6; 16		Stck. Pcs.	Profil Profile (mm)	Länge Length (mm)
SR44	Schrauben - Screws 4.0x60 Elementen befestigung - El.fixing		54		
SR44	Schrauben - Screws 4.0x60 EL1-EL3 befestigung zu Fussboden		18		
SR44	Schrauben - Screws 4.0x60 LT11		4		
SR55	Schrauben - Screws 5.0x70 PF1 befestigung - PF1 fixing		10		
H02	T-SCHARNIER - T-HINGE 150mm KZN		4		
R02	RIEGEL - LATCH 02- mit Schrauben - with screws		2		
R03	RIEGEL - LATCH 03		1		
	✓ - Bitte selber anpassen (falls nötig)! / Cut into length on site (if needed)!				
Kood	Sven 290x175.6; 16	Materjal	Leht	3/3	

Aufbau Anleitung für/Installation guide for "Sven 290x175.6; 16"

1. Fußboden/Floor

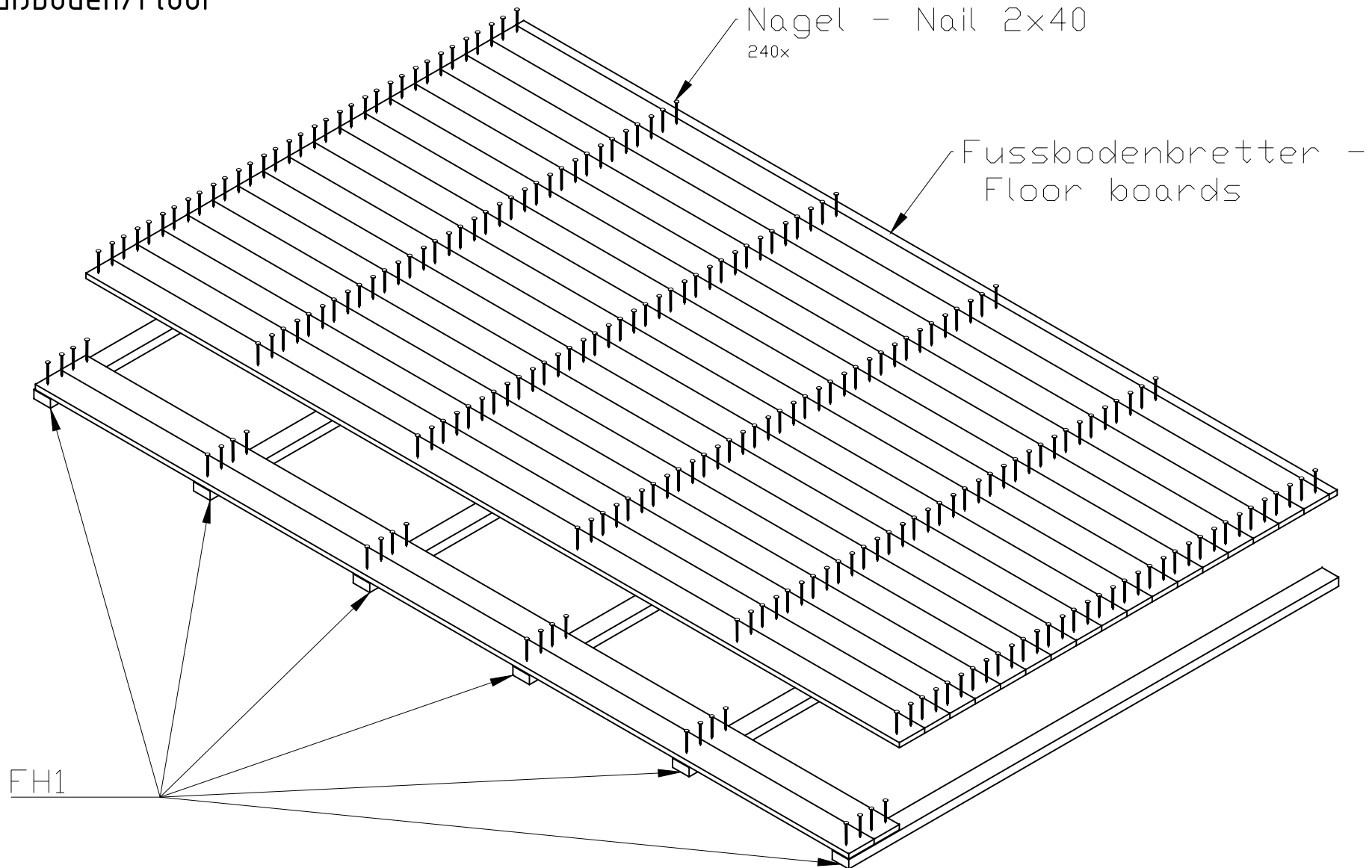

Aufbau Anleitung für/Installation guide for "Sven 290x175.6; 16"

2.1 Montage der Wandelemente / Assembly of wall elements

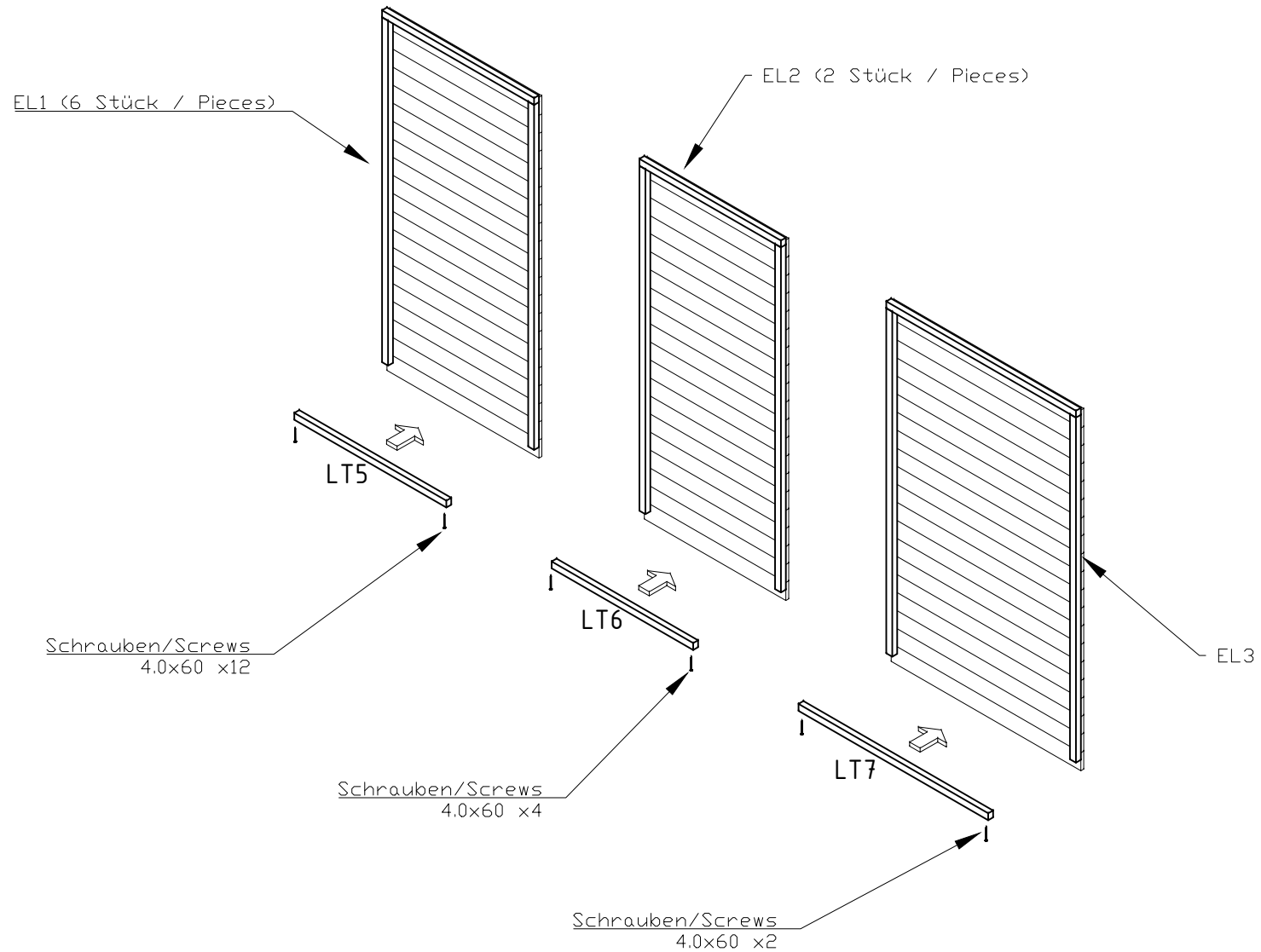

Aufbau Anleitung für/Installation guide for "Sven 290x175.6; 16"

2.2 Montage der Wandelemente / Assembly of wall elements

Das Wandelement an den Fundamentholz befestigen, nicht nur an den Fussbodenbrett! / Attach the wall elements to the foundation beams not only to the floorboards!

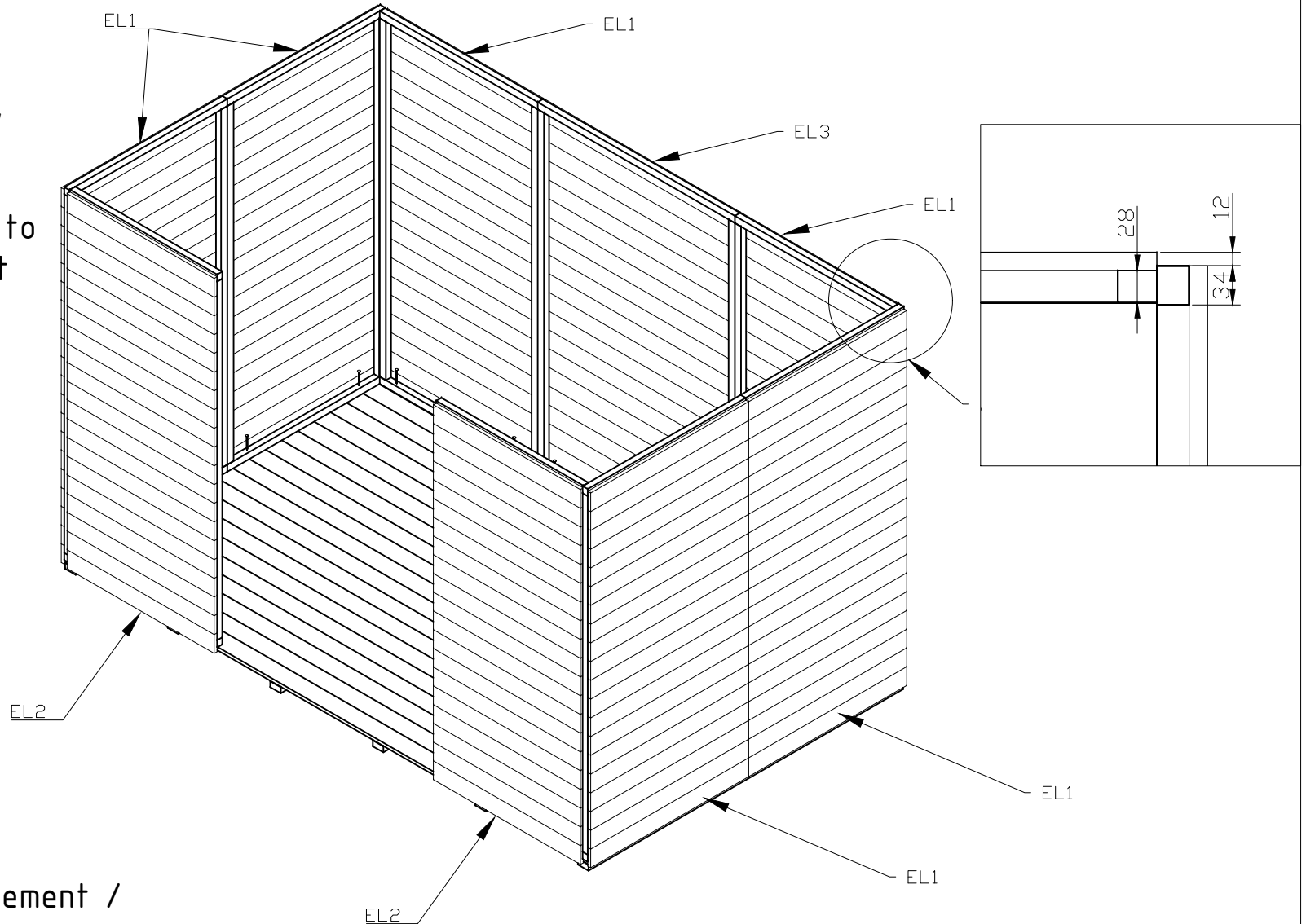

2 Schrauben 4.0x60 für Element /
2 Screws 4.0x60 per element.

Aufbau Anleitung für/Installation guide for "Sven 290x175.6; 16"

2.3 Montage der Wandelemente / Assembly of wall elements

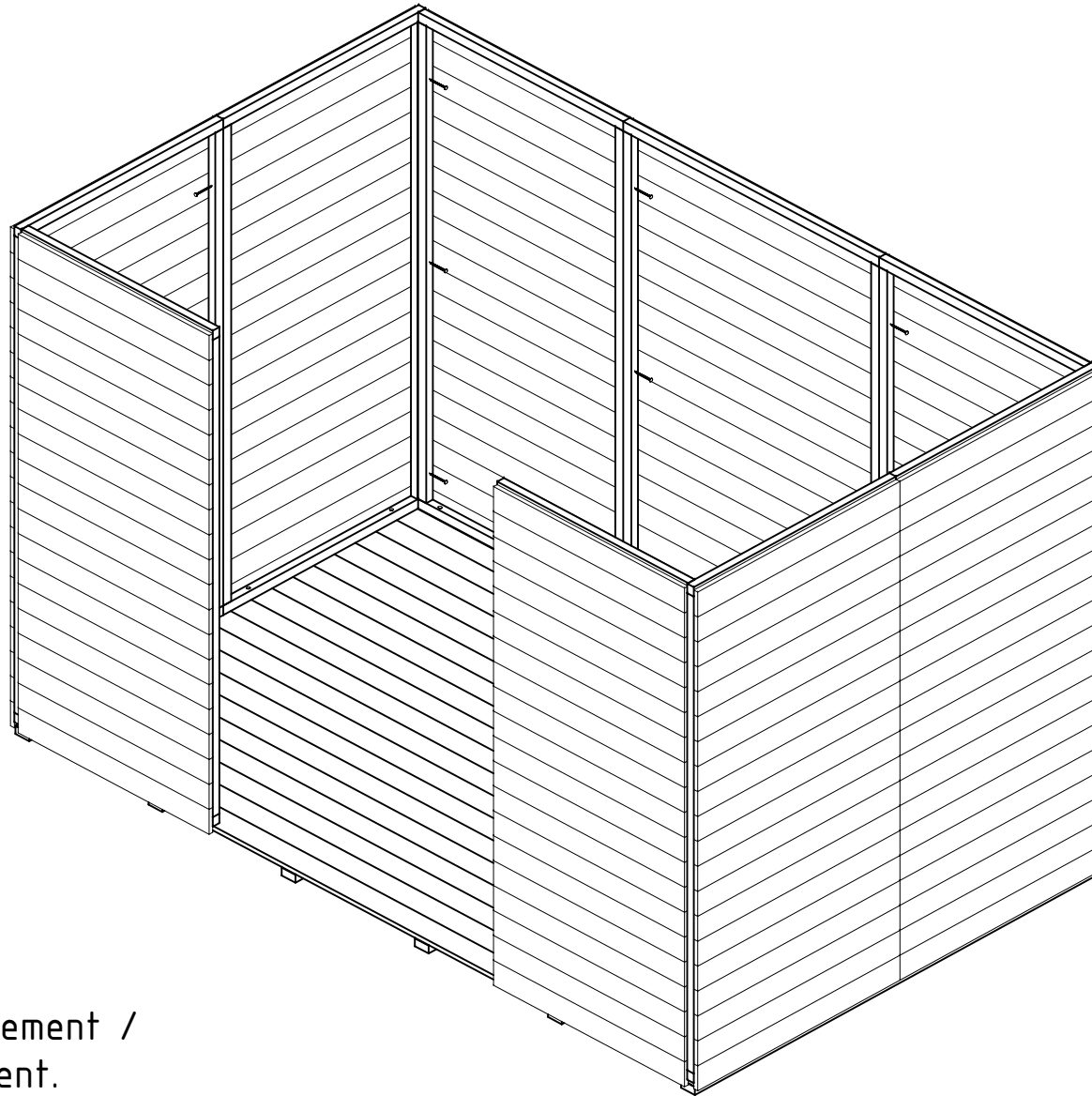

3 Schrauben 4.0x60 für Element /
3 Screws 4.0x60 per element.

Aufbau Anleitung für/Installation guide for "Sven 290x175.6; 16"

2.4 Montage der Wandelemente / Assembly of wall elements

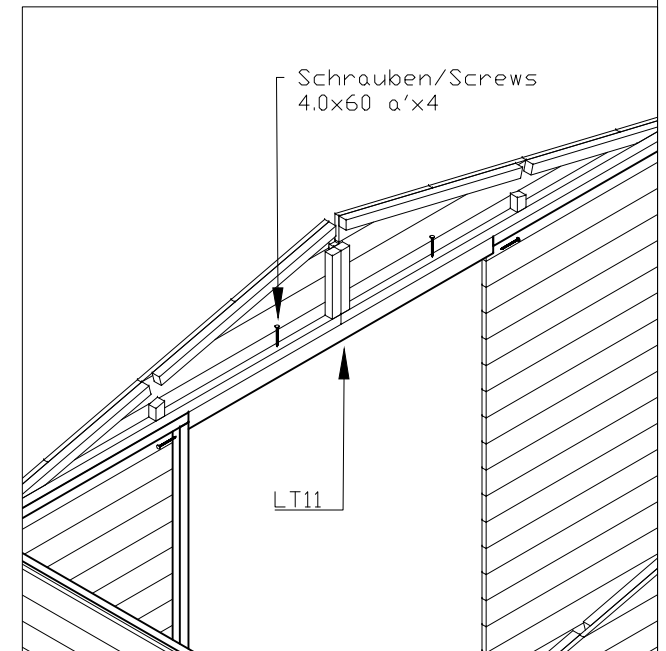
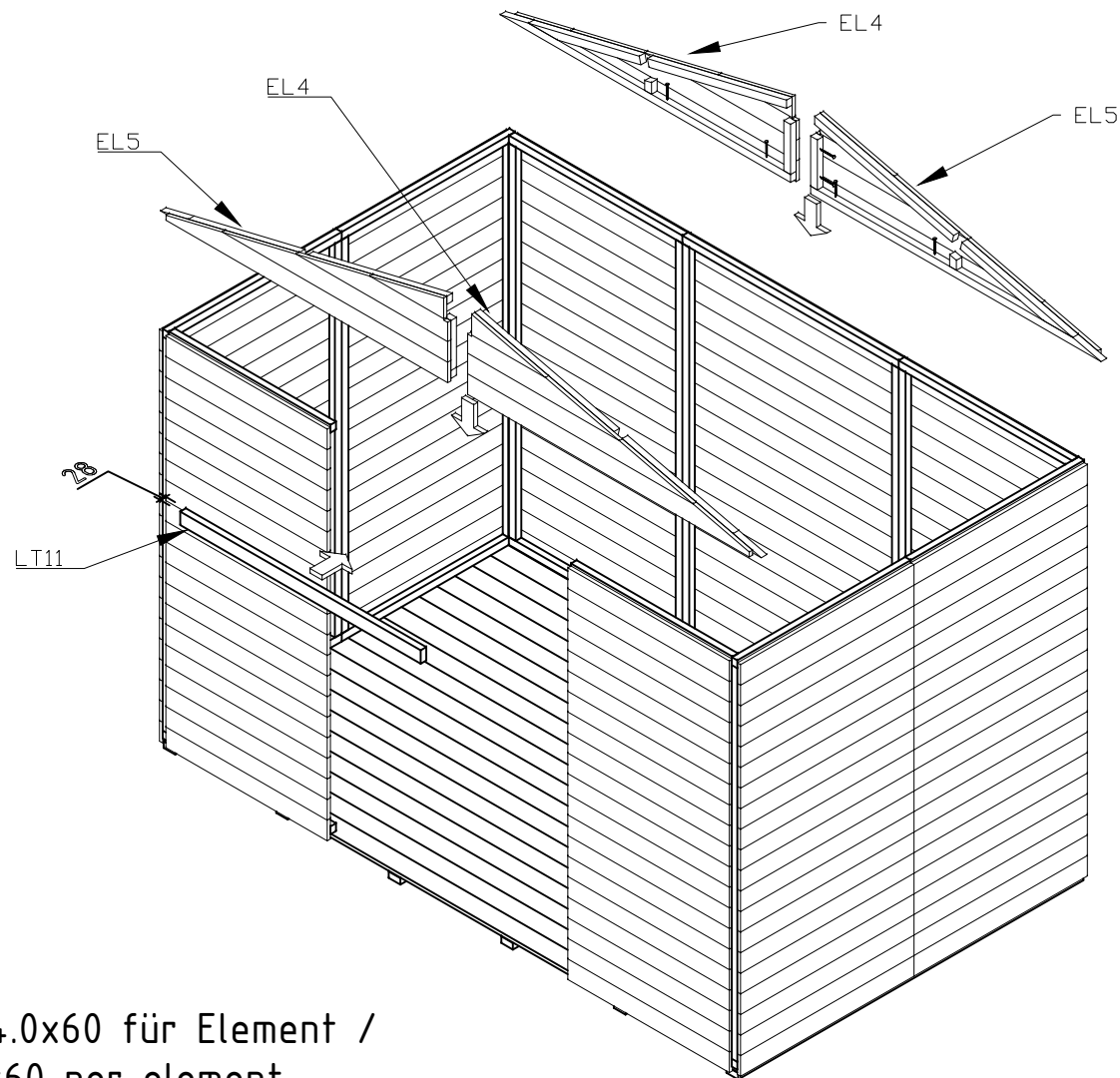

2 Schrauben 4.0x60 für Element /
2 Screws 4.0x60 per element.

Aufbau Anleitung für/Installation guide for "Sven 290x175.6; 16"

3. Pfetten/Purlins

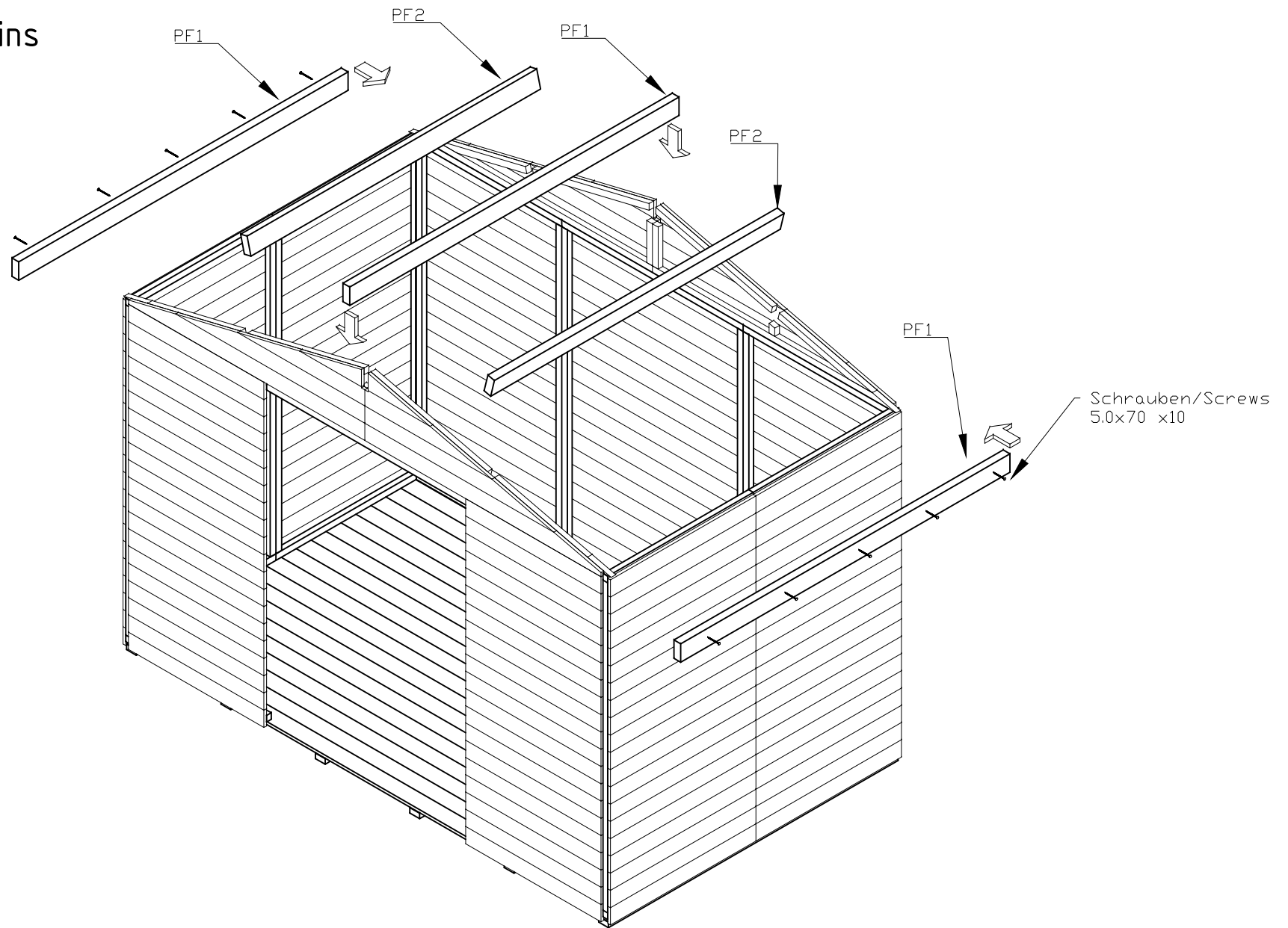

Aufbau Anleitung für/Installation guide for "Sven 290x175.6; 16"

4. Dachbretter/Roof boards

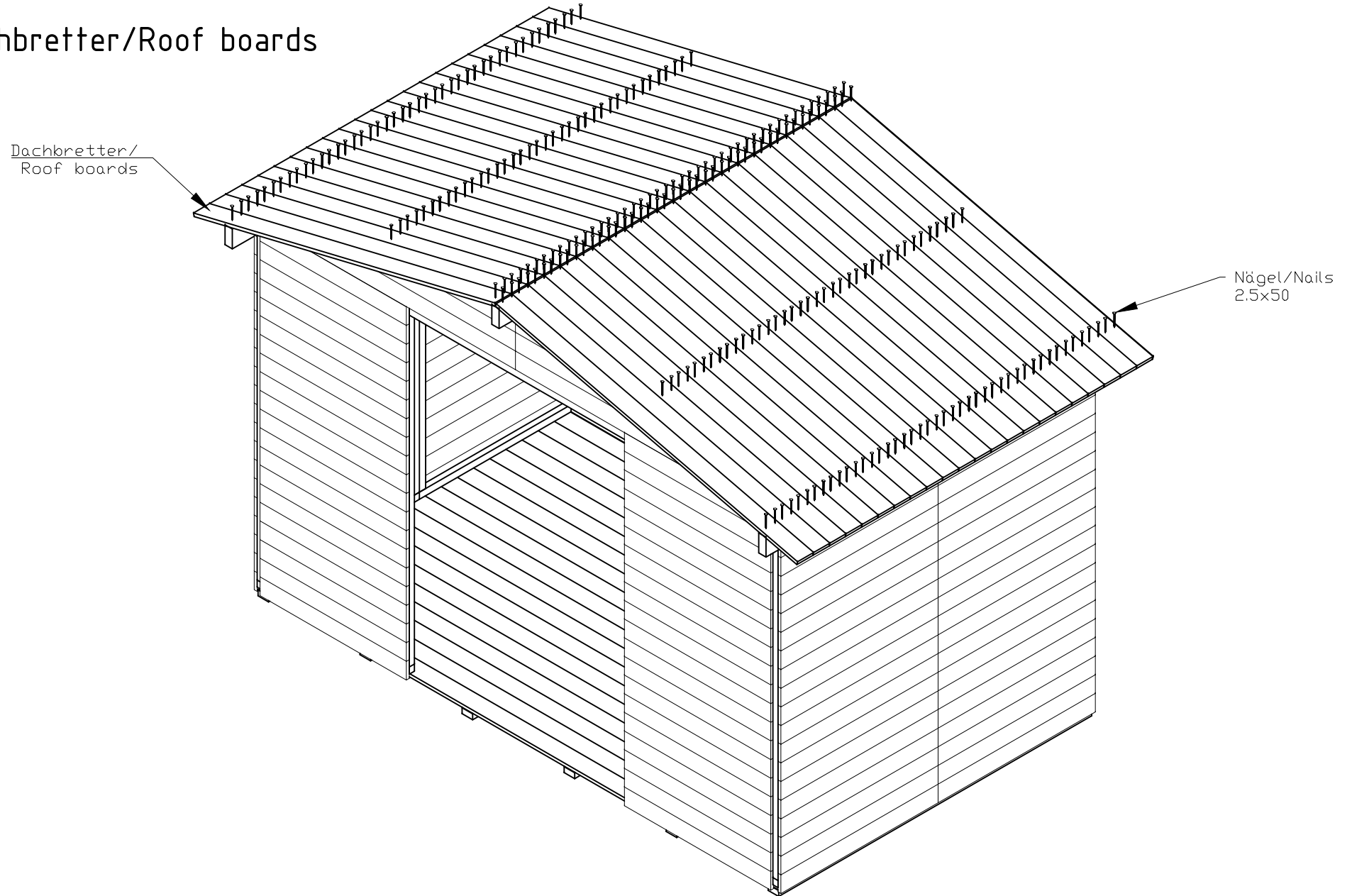

Aufbau Anleitung für/Installation guide for "Sven 290x175.6; 16"

5. Leisten (Dach)/Strips (Roof)

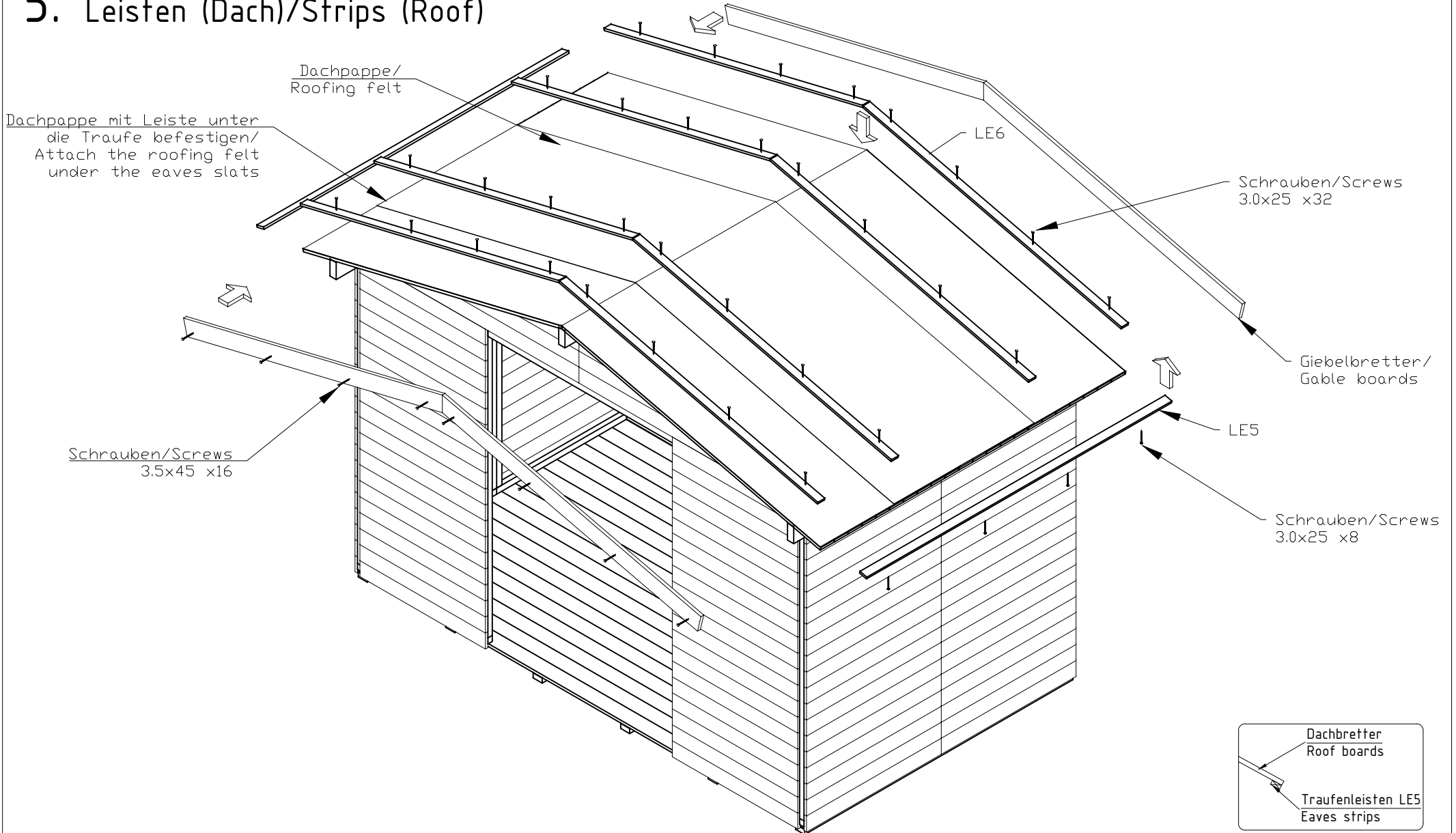

Aufbau Anleitung für/Installation guide for "Sven 290x175.6; 16"

6. Leisten/Strips

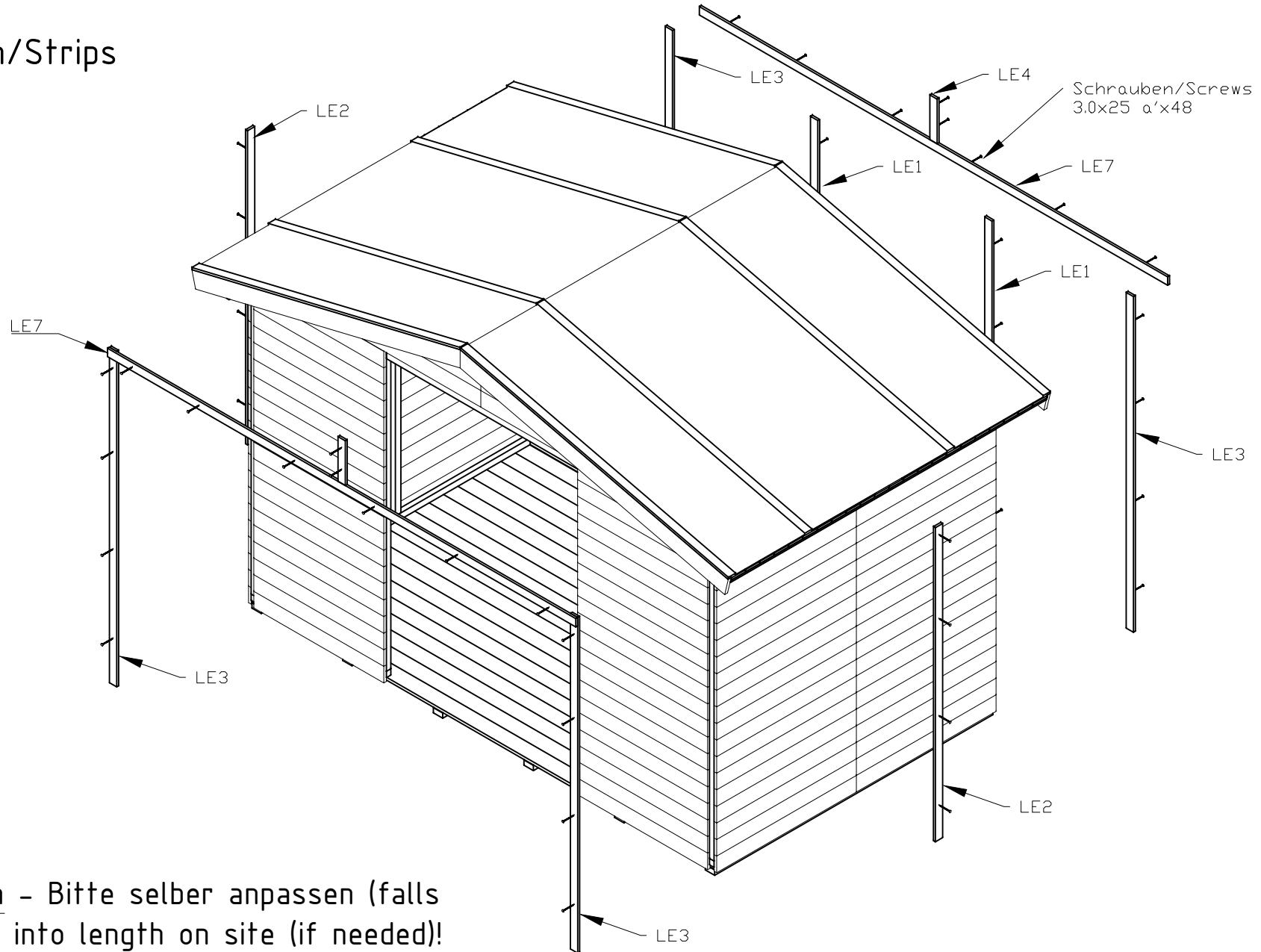

Leisten/Lath - Bitte selber anpassen (falls nötig)! / Cut into length on site (if needed)!

Aufbau Anleitung für/Installation guide for "Sven 290x175.6; 16"

7. Tür/Door

Unterkante der Tür bitte auf selbe Linie mit Unterkante des Wandelements befestigen / The lower edge of the door should be installed flush with the lower edge of the wall panel

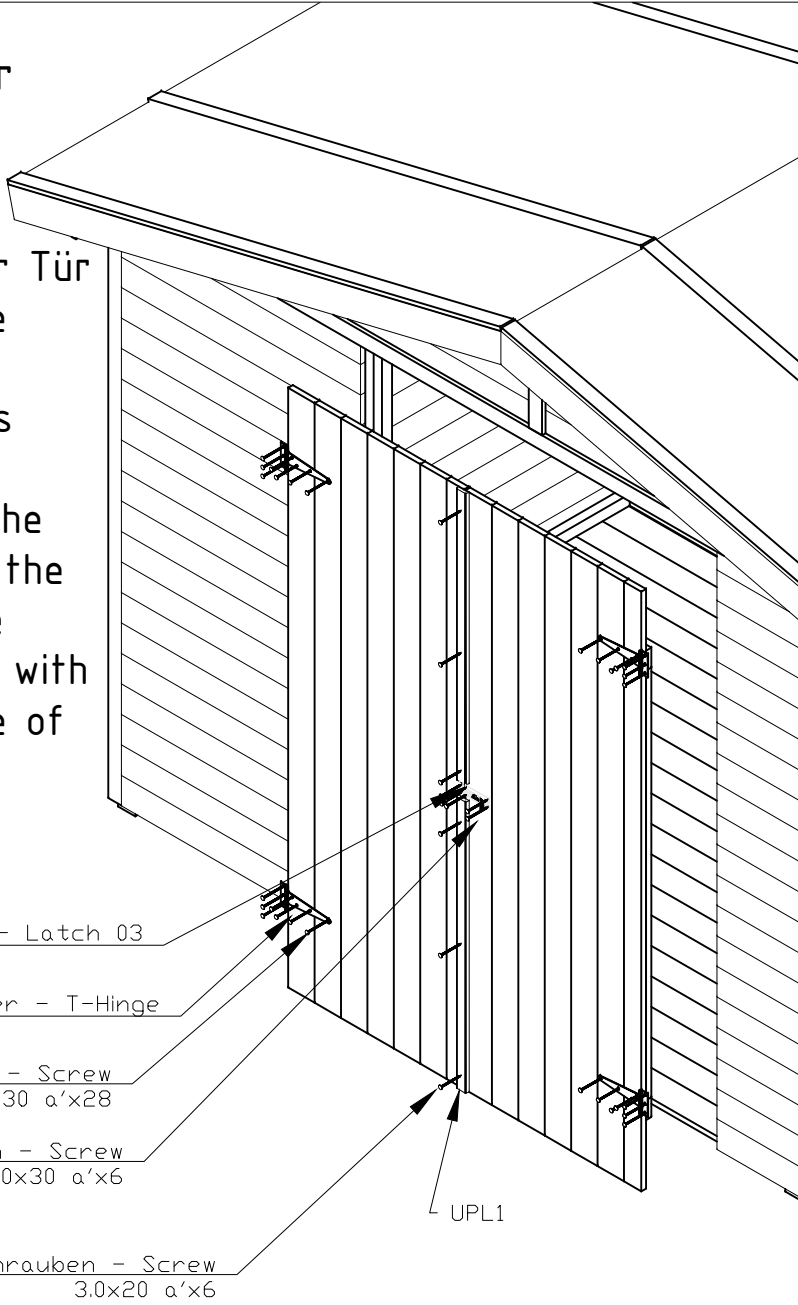

8. Tür/Door

